

2301D Digital Load Sharing and Speed Control for Engines

**Ordinary Locations—8273-101
Hazardous Locations—8273-135, -1000**

Installation and Operation Manual

IMPORTANT



This is the safety alert symbol. It is used to alert you to potential personal injury hazards. Obey all safety messages that follow this symbol to avoid possible injury or death.

DEFINITIONS

- **DANGER**—Indicates a hazardous situation which, if not avoided, will result in death or serious injury.
- **WARNING**—Indicates a hazardous situation which, if not avoided, could result in death or serious injury.
- **CAUTION**—Indicates a hazardous situation which, if not avoided, could result in minor or moderate injury.
- **NOTICE**—Indicates a hazard that could result in property damage only (including damage to the control).
- **IMPORTANT**—Designates an operating tip or maintenance suggestion.

WARNING

The engine, turbine, or other type of prime mover should be equipped with an overspeed shutdown device to protect against runaway or damage to the prime mover with possible personal injury, loss of life, or property damage.

The overspeed shutdown device must be totally independent of the prime mover control system. An overtemperature or overpressure shutdown device may also be needed for safety, as appropriate.



Read this entire manual and all other publications pertaining to the work to be performed before installing, operating, or servicing this equipment. Practice all plant and safety instructions and precautions. Failure to follow instructions can cause personal injury and/or property damage.



This publication may have been revised or updated since this copy was produced. To verify that you have the latest revision, be sure to check the Woodward website:

www.woodward.com/pubs/current.pdf

The revision level is shown at the bottom of the front cover after the publication number. The latest version of most publications is available at:

www.woodward.com/publications

If your publication is not there, please contact your customer service representative to get the latest copy.



Any unauthorized modifications to or use of this equipment outside its specified mechanical, electrical, or other operating limits may cause personal injury and/or property damage, including damage to the equipment. Any such unauthorized modifications: (i) constitute "misuse" and/or "negligence" within the meaning of the product warranty thereby excluding warranty coverage for any resulting damage, and (ii) invalidate product certifications or listings.

NOTICE

To prevent damage to a control system that uses an alternator or battery-charging device, make sure the charging device is turned off before disconnecting the battery from the system.

NOTICE

To prevent damage to electronic components caused by improper handling, read and observe the precautions in Woodward manual 82715, *Guide for Handling and Protection of Electronic Controls, Printed Circuit Boards, and Modules*.

Revisions—Text changes are indicated by a black line alongside the text.

Woodward Governor Company reserves the right to update any portion of this publication at any time. Information provided by Woodward Governor Company is believed to be correct and reliable. However, no responsibility is assumed by Woodward Governor Company unless otherwise expressly undertaken.

© Woodward 2000
All Rights Reserved

Contents

REGULATORY COMPLIANCE	IV
ELECTROSTATIC DISCHARGE AWARENESS	V
CHAPTER 1. GENERAL INFORMATION.....	1
Description.....	1
Applications	2
Control Options.....	2
References	3
CHAPTER 2. INSTALLATION.....	9
Introduction.....	9
Unpacking.....	9
Power Requirements	9
Location Considerations	9
Electrical Connections	10
Shields and Grounding.....	10
Setting Speed Range	11
Potential Transformer Connections.....	11
Current Transformer Connections.....	11
Load Sharing Lines.....	12
Power Supply	12
Discrete Inputs (Terminals 28–38)	13
Close to Run or Minimum Fuel (Terminal 31)	13
Failed Speed Signal Override (Terminal 32).....	14
Rated Speed (Terminal 33)	14
CB Aux/Droop Contact (Terminal 34).....	14
Raise Speed/Load Contact (Terminal 35).....	15
Lower Speed/Load Contact (Terminal 36)	16
Load Generator (Terminal 37).....	16
Base Load (Terminal 38).....	16
Actuator Output	16
Speed and Phase Matching (SPM) Synchronizer.....	17
(Analog Input #1; Terminals 19-20).....	17
Remote Speed/Load Set Point/Auxiliary Input	17
(Analog Input #2; Terminals 22-23).....	17
Speed Sensor.....	17
Relay Driver Outputs (Terminals 41–44).....	18
Analog Output #1 (Terminals 16-17).....	18
RS-232 Communication Port.....	18
Installation Check-out Procedure	19
CHAPTER 3. ENTERING CONTROL SET POINTS.....	20
Introduction.....	20
Watch Window PC Interface.....	20
Configure Menu Descriptions	22
Service Menu Descriptions.....	24
I** ANALOG INPUTS SETTINGS **	37
Adjust For Stable Operation	43
Speed Setting Adjustment.....	43
Dynamic Adjustment.....	44
Actuator Compensation Adjustment.....	44
Low Idle Speed Adjustment.....	44
Ramp Time Adjustment.....	44

Contents

Raise/Lower Time Adjustment.....	45
Start Fuel Limit Adjustment	45
Speed Sensor Check.....	45
Current Transformer (CT) Phasing Check	45
Phase Correction Procedure	46
Load Calibration Adjustment	49
Droop Adjustment	49
CHAPTER 4. DESCRIPTION OF OPERATION.....	50
Introduction	50
Speed Control.....	50
Control Dynamics	51
Minimum Fuel Function	52
Maximum Fuel Function	53
Start Limit Function.....	53
Speed/Load Reference and Ramps	54
Speed Reference and Ramp Functions	54
Speed Bias and Synchronizer Summing.....	55
Load Reference and Ramp Functions.....	56
Droop Function	58
CHAPTER 5. TROUBLESHOOTING	64
Introduction	64
Troubleshooting Procedure	64
Control Start-up	64
Control Test and Calibration.....	65
CHAPTER 6. SERVICE OPTIONS.....	72
Product Service Options.....	72
Woodward Factory Servicing Options	73
Returning Equipment for Repair.....	73
Replacement Parts	74
Engineering Services.....	74
How to Contact Woodward.....	75
Technical Assistance	75
APPENDIX. SERVICE/CONFIGURE CHART.....	76
2301D CONTROL SPECIFICATIONS.....	80
DECLARATIONS	81

Illustrations and Tables

Figure 1-1a. 2301D Outline Drawing (Ordinary Locations)	4
Figure 1-1b. 2301D Outline Drawing (Hazardous Locations)	5
Figure 1-2. 2301D Plant Wiring Diagram (sheet 1)	6
Figure 1-2. 2301D Plant Wiring Diagram (sheet 2)	7
Figure 1-2. 2301D Plant Wiring Diagram (notes)	8
Figure 2-1. Installation of Wiring into Terminal.....	11
Figure 2-2. Droop Contact and Circuit Breaker Auxiliary Contact.....	15
Figure 3-1. Control Gain as a Function of Speed Error.....	25
Figure 3-2. Speed Filter.....	26
Figure 3-3. Typical Transient Response Curves.....	27
Figure 3-4. Non-linear Valve Power Curve.....	30
Figure 3-5. Sample Engine Plot	31
Figure 3-6. Linearized Gain Plot.....	31
Figure 3-7. Start Limit Function	34
Figure 3-8. Temporary Wiring for Transformer Phase Correction.....	47
Figure 3-9. Droop Adjustment	49
Figure 4-1. Speed Control System	51
Figure 4-2. Start Limit Function	53
Figure 4-3. Remote Speed Reference	55
Figure 4-4. Paralleling System	59
Figure 4-5. Droop Mode	60
Figure 4-6. Isochronous Mode	61
Figure 4-7. Droop/Isochronous Load Sharing	62
Figure 4-8. Isochronous Load Sharing	62
Table 4-1. Description of Discrete Inputs While in Load Control.....	58

Regulatory Compliance

European Compliance for CE Mark

These listings are limited only to those units bearing the CE Marking.

EMC Directive: Declared to 89/336/EEC COUNCIL DIRECTIVE of 03 May 1989 on the approximation of the laws of the member states relating to electromagnetic compatibility.

Low Voltage Directive: Declared to the 73/23/EEC COUNCIL DIRECTIVE of 19 February 1973 on the harmonization of the laws of the Member States relating to electrical equipment designed for use within certain voltage limits.

North American Compliance

These listings are limited only to those units bearing the appropriate CSA identification and marking.

CSA: CSA Certified for Class I, Division 2, Groups A, B, C, D, T4 Hazardous Locations and ordinary locations at 70 °C ambient. For use in Canada and the United States.
Certificate 1150575

NOTE—Wiring must be in accordance with applicable electric codes with the authority having jurisdiction.

Marine Compliance

Bureau Veritas: BV Rules Part C, June 2000

Det Norske Veritas: Standard for Certification, No. 2.4.2001

Germanischer Lloyd: Additional Rules and Guidelines, Part 1, 2001

Lloyd's Register of Shipping: Type Approval System, Test Specification Number 1, 2002

Registro Italiano Navale: RINA Rules 2001 – Part C

NOTE—Marine certifications apply to specific models only.

Connector J1 must not be used in hazardous locations.

The control must be installed in a suitable enclosure. The final combination must be approved by the local authority having jurisdiction.

Connect the ground terminal to earth ground.



WARNING

EXPLOSION HAZARD—Do not remove covers or connect/disconnect electrical connectors unless power has been switched off or the area is known to be non-hazardous.

Substitution of components may impair suitability for Class I, Division 2.



AVERTISSEMENT

RISQUE D'EXPLOSION—Ne pas enlever les couvercles, ni raccorder / débrancher les prises électriques, sans vous en assurez auparavant que le système a bien été mis hors tension; ou que vous vous situez bien dans une zone non explosive.

La substitution de composants peut rendre ce matériel inacceptable pour les emplacements de Classe I, Division 2.

Electrostatic Discharge Awareness

All electronic equipment is static-sensitive, some components more than others. To protect these components from static damage, you must take special precautions to minimize or eliminate electrostatic discharges.

Follow these precautions when working with or near the control.

1. Before doing maintenance on the electronic control, discharge the static electricity on your body to ground by touching and holding a grounded metal object (pipes, cabinets, equipment, etc.).
2. Avoid the build-up of static electricity on your body by not wearing clothing made of synthetic materials. Wear cotton or cotton-blend materials as much as possible because these do not store static electric charges as much as synthetics.
3. Keep plastic, vinyl, and Styrofoam materials (such as plastic or Styrofoam cups, cup holders, cigarette packages, cellophane wrappers, vinyl books or folders, plastic bottles, and plastic ash trays) away from the control, the modules, and the work area as much as possible.
4. Do not remove the printed circuit board (PCB) from the control cabinet unless absolutely necessary. If you must remove the PCB from the control cabinet, follow these precautions:
 - Do not touch any part of the PCB except the edges.
 - Do not touch the electrical conductors, the connectors, or the components with conductive devices or with your hands.
 - When replacing a PCB, keep the new PCB in the plastic antistatic protective bag it comes in until you are ready to install it. Immediately after removing the old PCB from the control cabinet, place it in the antistatic protective bag.

NOTICE

To prevent damage to electronic components caused by improper handling, read and observe the precautions in Woodward manual 82715, *Guide for Handling and Protection of Electronic Controls, Printed Circuit Boards, and Modules*.

Chapter 1.

General Information

Description

The Woodward 2301D controls load sharing and speed of generators driven by diesel or gaseous engines. (These power sources are referred to as “prime movers” throughout this manual.) The 2301D is a microprocessor-based digital control designed to include the functions of and be compatible with 2301A load sharing controls. The increased flexibility of software allows the 2301D to include control functions that required additional equipment in previous versions of 2301A control systems. The 2301D therefore is suitable for upgrading existing control systems or increased functionality in new installations.

The control is housed in a sheet-metal chassis and consists of a single printed circuit board. The 2301D is set up and configured through an external computer connected at the 9-pin connector at the front of the control. The configuration software is supplied with each control.

The 2301D provides control in either isochronous, droop, or base load. The 2301D will allow for soft load transfer when being added to or removed from a bus.

The isochronous mode is used for constant prime mover speed with:

- Single prime mover operation or
- Two or more prime movers controlled by Woodward load sharing control systems on an isolated bus

The droop mode is used for speed control as a function of load with:

- Single prime mover operation on an infinite bus or
- Parallel operation of two or more prime movers

The base load mode provides constant load level operation against a bus with the load controlled by the 2301D.

- The load setting is set by a fixed reference,
- or an external input analog input,
- or external contact control of the reference.

The 2301D Control Hardware includes:

- 1 Load Sensor
- 1 Actuator Driver
- 1 MPU Speed Sensor
- 1 Configurable Analog Output
- 2 Configurable Analog Inputs
- 8 Discrete (Switch) Inputs
- 4 Discrete (Relay Driver) Outputs

The following is an example of the typical hardware needed for a 2301D system controlling a single prime mover and generator:

- A 2301D electronic control
- An external 18 to 40 Vdc power source
- A speed-sensing device
- A proportional actuator to position the fuel-metering device and
- Current and potential transformers for measuring the load carried by the generator

The engine and generator synchronous speed (50 or 60 Hz Generator Frequency) needs to be within 300 to 3600 rpm. The frequency from the magnetic pickup must be within the range of 100 to 20 000 Hz at rated speed. The 2301D speed range needs to be configured using an external computer during installation.

These 2301D controls operate with an input of 18 to 40 Vdc.

Applications

Because of the configuration software available in the 2301D hardware, application variations can now be selected using an external computer. Changing the application to accommodate engine speed range, gear teeth, and selection of forward or reverse acting actuator is a matter of software setup rather than changing hardware. See Chapter 3 to enter control set points.



WARNING

The speed range is factory set for 900 rpm, 450 Hz. Using the wrong speed configuration could cause an overspeed with resulting damage to equipment or personal injury or death.

The 2301D Control can be configured for forward- or reverse-acting applications. In reverse-acting systems, the actuator calls for more fuel when the actuator voltage decreases. Complete loss of voltage to the actuator will drive the actuator to full fuel. This allows a backup mechanical ballhead governor to take control rather than shut down the prime mover as would a direct-acting system.

IMPORTANT

External wiring connections for reverse-acting controls are identical to those for direct-acting controls.

Control Options

Here is a brief summary of programmable options in addition to speed range and actuator type:

- Actuator current range 0–20 mA, 4–20 mA, 0–200 mA.
- Speed trim with external raise and lower switches. Tunable rates.
- External setting of analog speed reference input or an external analog base load reference.
- Multiple dynamics options—
 - single dynamics setting
 - selection of 2 sets of dynamics switched with Circuit Breaker Aux input
 - 5 slope gain settings
 - error window gain ratio
- Start fuel limiter
- Analog output
- Discrete outputs

Woodward application engineers are always available to assist you in selection of the correct control for your system, or to answer questions concerning control installation, operation, or calibration. Contact any Woodward office.

References

The following publications contain additional product or installation information on Load Sharing and Speed Controls, and related components. They can be ordered from any Woodward office.

Manual	Title
25070	<i>Electric Governor Installation Guide</i>
25195	<i>Governing Fundamentals</i>
82384	<i>SPM-A Synchronizer</i>
82510	<i>Magnetic Pickups and Proximity Switches for Electric Governors</i>
82715	<i>Guide for Handling and Protection of Electronic Controls, Printed Circuit Boards, and Modules</i>
26007	<i>Woodward Watch Window Software Getting Started</i>

Product Spec	Title
03204	<i>2301D Digital 2301 Control</i>
82383	<i>SPM-A Synchronizer</i>
82516	<i>EG3P/3PC Actuator</i>
82575	<i>EGB1P/2P Governor/Actuator</i>

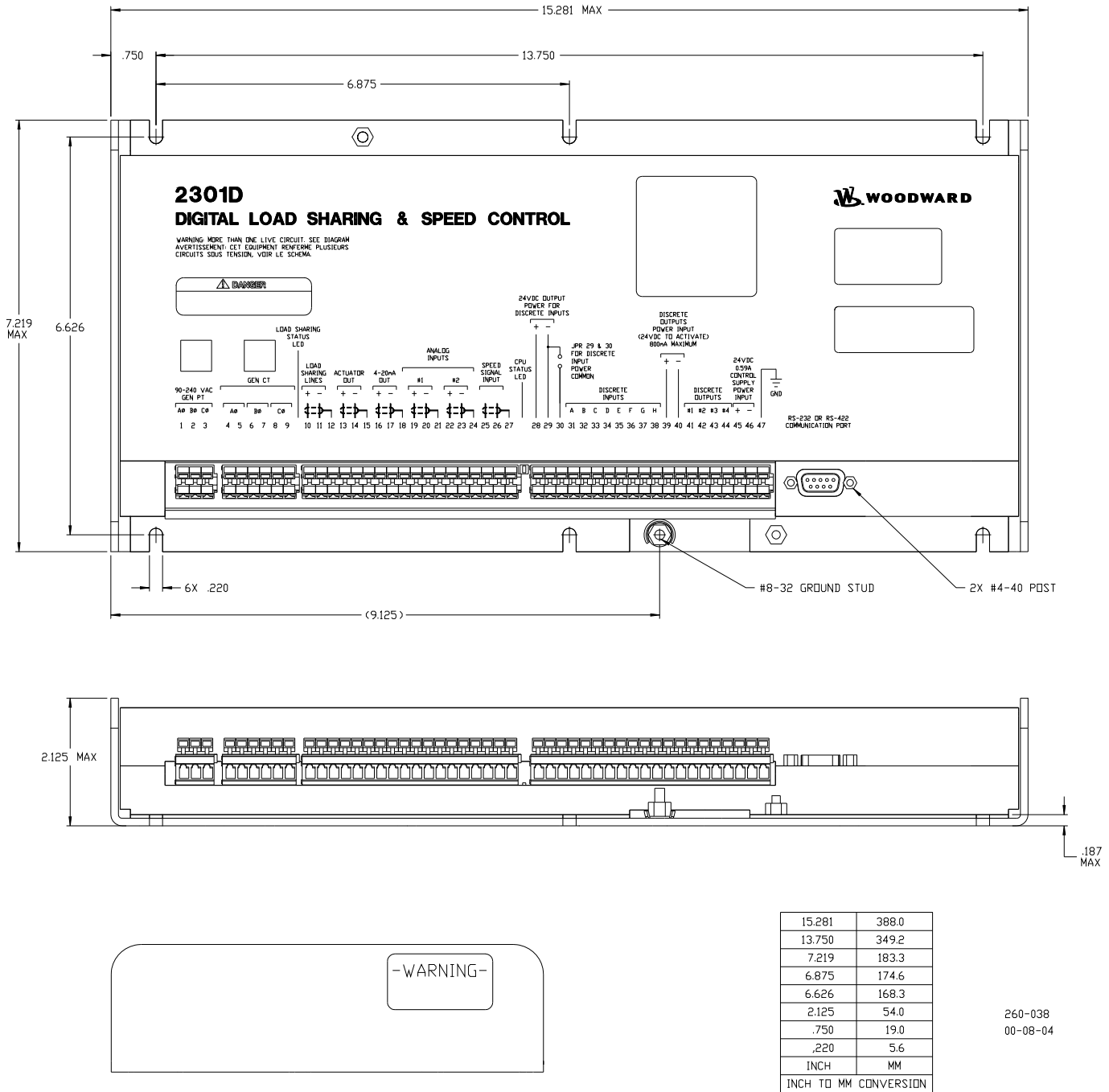

Figure 1-1a. 2301D Outline Drawing (Ordinary Locations)

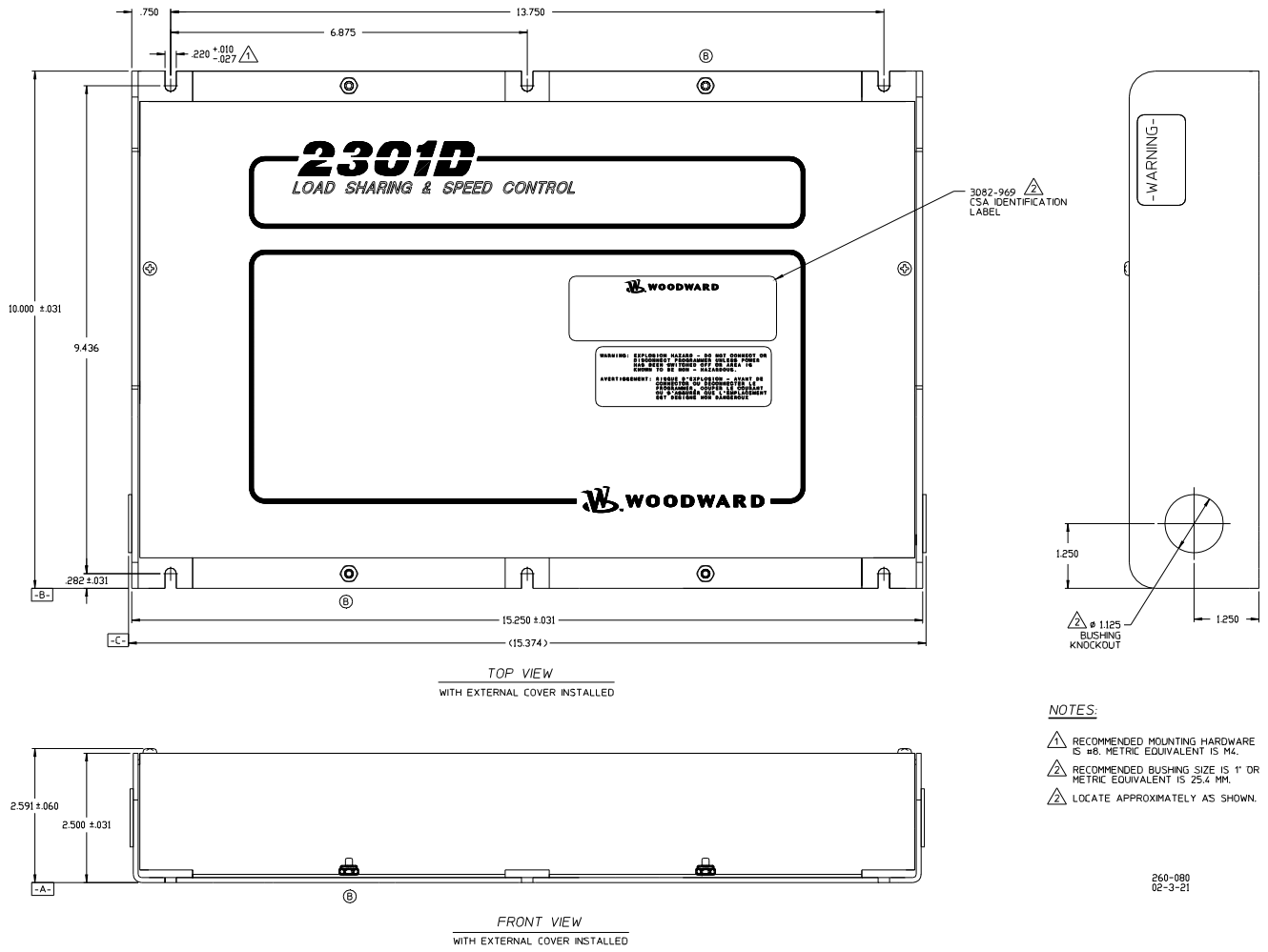
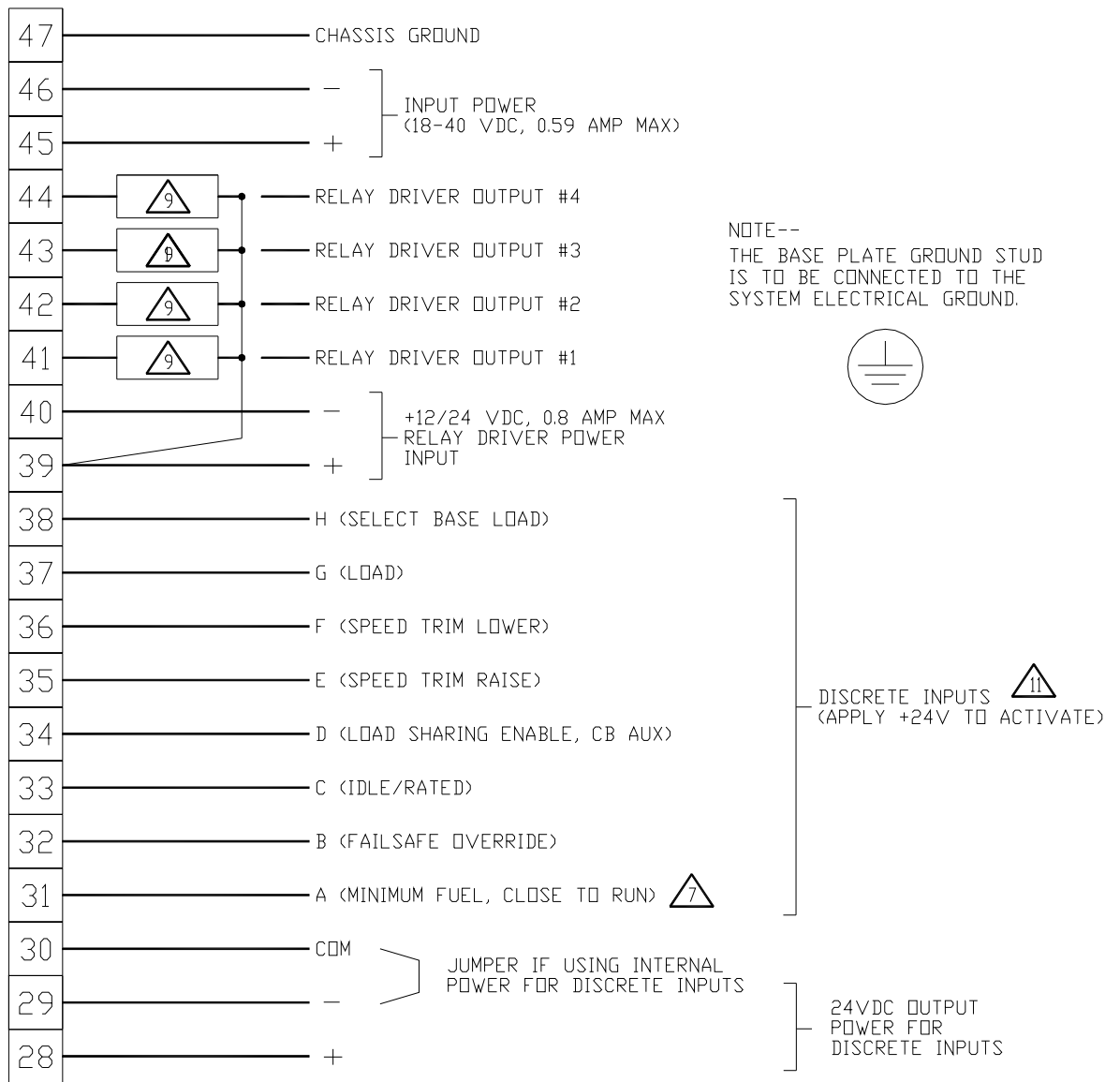

Figure 1-1b. 2301D Outline Drawing (Hazardous Locations)



260-039E
03-07-25

Figure 1-2. 2301D Plant Wiring Diagram (sheet 2)

NOTES:

- 1 SHIELDED WIRES TO BE TWISTED PAIRS, WITH SHIELD GROUNDED AT CONTROL END ONLY.
- 2 POINT OF GROUNDING IF REQUIRED BY WIRING CODE.
- 3 INTERNAL CURRENT TRANSFORMER BURDEN MUST BE CONNECTED ACROSS POWER SOURCE CURRENT TRANSFORMER AT ALL TIMES, TO PREVENT LETHAL HIGH VOLTAGES.
- 4 POWER SOURCE CURRENT TRANSFORMERS SHOULD BE SIZED TO PRODUCE 5 A SECONDARY CURRENT WITH MAXIMUM GENERATOR CURRENT, CURRENT TRANSFORMER BURDEN IS LESS THAN 0.1 VA PER PHASE.
- 5 WITH A BALANCED THREE PHASE LOAD AND UNITY POWER FACTOR, THE CURRENT TRANSFORMERS SHOULD BE WIRED IN THE CORRECT POTENTIAL LEG AND MUST BE PHASED AS FOLLOWS:
 PHASE A: POTENTIAL TERMINAL 1, WITH RESPECT TO NEUTRAL, IN PHASE WITH CT TERMINALS 4 () TO 5.
 PHASE B: POTENTIAL TERMINAL 2, WITH RESPECT TO NEUTRAL, IN PHASE WITH CT TERMINALS 6 () TO 7.
 PHASE C: POTENTIAL TERMINAL 3, WITH RESPECT TO NEUTRAL, IN PHASE WITH CT TERMINALS 8 () TO 9.
- 6 FOR OPTIONAL CURRENT TRANSFORMER CONNECTION, SEE DETAIL "A".
- 7 **WARNING:** DO NOT USE FOR EMERGENCY SHUTDOWN. THE PRIME MOVER SHOULD BE EQUIPPED WITH SEPARATE OVERSPEED, OVERTEMPERATURE OR OVERPRESSURE SHUTDOWN DEVICE(S) TO PROTECT AGAINST RUNAWAY OR DAMAGE TO THE PRIME MOVER WITH POSSIBLE PERSONAL INJURY OR LOSS OF LIFE.
- 8 IF METERS ARE NOT USED, JUMPERS MUST BE INSTALLED IN PLACE OF METERS SHOWN.
- 9 INDICATES RELAY COIL OR LAMP, 200 MA MAXIMUM PER CHANNEL.
- 10 OPTIONAL SEE BOM
- 11 DISCRETE INPUTS WITH CABLE LENGTHS GREATER THAN 30 METERS THAT ARE USED FOR CRITICAL FUNCTIONS, SUCH AS EMERGENCY STOP, SHOULD NOT BE FLOATED IN EITHER AN ON OR OFF STATE. THESE INPUTS SHOULD BE SWITCHED TO +24 VDC OR GROUND.

260-039C
00-07-26

Figure 1-2. 2301D Plant Wiring Diagram (notes)

Chapter 2. Installation

Introduction

This chapter contains general installation instructions for the 2301D control. Power requirements, environmental precautions, and location considerations are included to determine the best location for the control. Additional information includes unpacking instructions, electrical connections, and an installation check-out procedure.

Unpacking

Before handling the control, read page iv, “Electrostatic Discharge Awareness”. Be careful when unpacking the electronic control. Check the control for signs of damage such as bent or dented panels, scratches, and loose or broken parts. If any damage is found, immediately notify the shipper.

Power Requirements

The 2301D control requires a voltage source of 18 to 40 Vdc, with a current capacity of at least 900 mA for operating power. If a battery is used for operating power, an alternator or other battery charging device is necessary to maintain a stable supply voltage.

NOTICE

To prevent damage to the control, make sure that the alternator or other battery-charging device is turned off or disconnected before disconnecting the battery from the control.

Location Considerations

This product is intended for installation in a “closed electrical operating area” or in an enclosed industrial control cabinet. Consider these requirements when selecting the mounting location:

- Adequate ventilation for cooling
- Space for servicing and repair
- Protection from direct exposure to water or to a condensation-prone environment
- Protection from high-voltage or high-current devices, or devices which produce electromagnetic interference
- Avoidance of vibration
- Selection of a location that will provide an operating temperature range of –40 to +70 °C (–40 to +158 °F)
- The control must NOT be mounted on the engine.

Electrical Connections

All inputs and outputs are made through screwless spring-actuated terminal blocks. For EMI reasons, it is recommend that all low-current wires be separated from all high-current wire.

The spring clamp can be actuated by using a standard 2.5 mm or 3/32 inch flat bladed screwdriver. The terminal blocks accept wires from 0.08–4 mm² (27–12 AWG). Two 18 AWG or three 20 AWG wires can be easily installed in each terminal. Wires for the fixed mounted power terminals should be stripped 5–6 mm (0.22 inch) long.

IMPORTANT

Do not tin (solder) the wires that terminate at the terminal blocks. The spring-loaded terminal blocks are designed to flatten stranded wire, and if those strands are tinned together, the connection loses surface area and is degraded.

Shields and Grounding

An individual shield termination is provided at the terminal block for each of the signals requiring shielding. All of these inputs should be wired using shielded, twisted-pair wiring. The exposed wire length beyond the shield should be limited to one 25 mm (1 inch). Relay outputs, contact inputs, and power supply wiring do not normally require shielding, but can be shielded if desired.

The 2301D is designed for shield termination to earth ground at the control. If intervening terminal blocks are used in routing a signal, the shield should be continued through the terminal block. If shield grounding is desired at the terminal block, it should be ac coupled to earth. All other shield terminations except at the control should be ac coupled to earth through a capacitor. A 1000 pF, 500 V capacitor is sufficient. The intent is to provide a low impedance path to earth for the shield at frequencies of 150 kHz and up. Multiple direct connections of a shield to earth risk high levels of current to flow within the shield (exception, see note below on cabinet installations).

Shields can be grounded at both ends (2301D and load) if the cable length is sufficiently short (i.e. within a cabinet) to prevent ground loop current in the shield.

IMPORTANT

Cabinet Installations: If the 2301D is installed in a cabinet, shielded I/O can be terminated directly to the cabinet (earth ground) at the entry to the cabinet, as well as at the control.

For EMC reasons, it is recommend that all low-current wires be separated from all high-current wires. Input Power ground terminal should also be wired to earth ground.

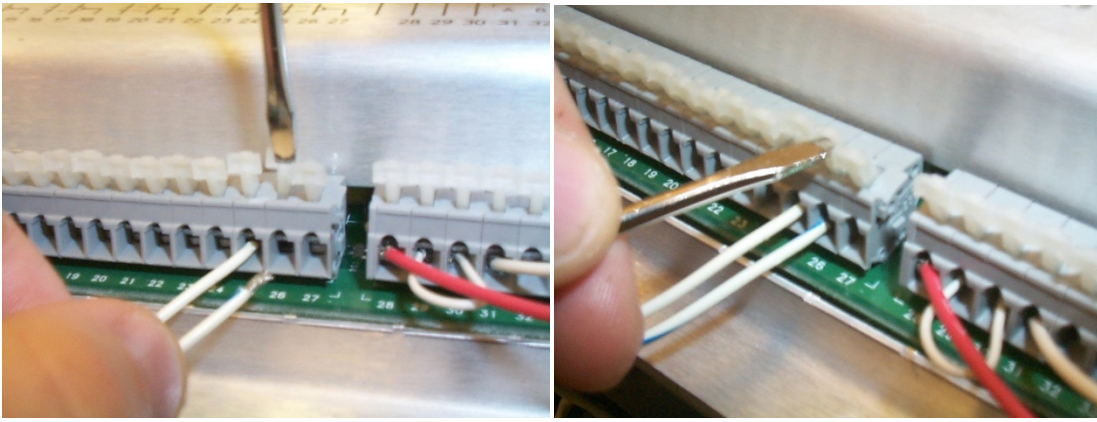

Figure 2-1. Installation of Wiring into Terminal

Setting Speed Range

The Microprocessor inside the 2301D calculates the speed range to be used by entering the engine/generator synchronous speed and number of gear teeth. This configured speed sets the hardware-to-software scaling. The rated speed setting is set in service as the speed reference selected when the Rated switch is closed..

! WARNING

The number of gear teeth is used by the control to convert pulses from the speed sensing device to engine rpm. To prevent possible serious injury from an overspeeding engine, make sure the control is properly programmed to convert the gear-tooth count into engine rpm. Improper conversion could cause engine overspeed.

! WARNING

The speed range is factory set for 450 Hz, 900 rpm (30 teeth). Refer to Chapter 3 to change speed range and prevent possible overspeed. Using the wrong speed range could cause an overspeed with resulting damage to equipment or personal injury or death.

Potential Transformer Connections

Connect the potential transformer secondary leads to the following terminals:

- Phase A to terminal 1
- Phase B to terminal 2
- Phase C to terminal 3

The potential transformer secondary line-to-line voltage must produce 90 to 120 Vac or 200 to 240 Vac. Refer to the plant wiring diagram, Figure 1-2.

Current Transformer Connections

The standard method of connecting the current transformers is shown in the plant wiring diagram, Figure 1-2. An alternate method is the open delta connection shown in the insert in the plant wiring diagram.

Load Sharing Lines

The Load Sharing Lines provide an analog communication path between compatible controls. The 2301D provides an internal relay for connecting the Load Sharing Signal to the internal circuitry at the appropriate times. When the internal relay is closed, a green LED will illuminate between terminals 9 and 10. Because the load-sharing-line relay is contained in the control, no relay is required between the control and the load-sharing-line bus. Use shielded cable and connect the load-sharing lines directly to terminals 10(+) and 11(-). Connect the shield to terminal 12. When all controls in the system are of the 2301D or 2301A types, the shields may be connected continuously between controls. When load sharing with different controls, do not connect the shields at the point where connections are made to the load-sharing-line bus. The droop contact for selecting droop or isochronous operation is wired in series with the circuit-breaker auxiliary contact between terminal 34 and terminal 28 (see CB Aux/Droop contact).

When running a single unit on an infinite bus with an external load control device, terminals 34 and 37 must be connected to terminal 28 to connect the Load Matching Circuit to the load-sharing lines. The load-sharing lines must be wired to the external load control device. The circuit-breaker auxiliary contact will then be connected to this device and not to the 2301D.

Power Supply

Run the power leads directly from the power source to the control, connecting the negative lead to terminal 46, and the positive lead to terminal 45.

When power is applied, the 2301D begins performing internal memory tests to 'boot-up' the processor, which takes approximately 30 seconds to complete. The CPU Status LED between terminals 27 and 28 remains on during this boot-up. The control will remain in I/O lock and will not control the prime mover until the boot-up is complete. For systems requiring fast start functions, it will be necessary to continuously power the 2301D.

WARNING

DO NOT attempt to start the prime mover while the CPU Status LED is ON.

WARNING

DO NOT apply power to the control at this time. Applying power before a control is completely connected may damage the control.

IMPORTANT

The 18–40 Vdc input power must be supplied from a power supply/battery charger certified to IEC standard with SELV (Safety Extra Low Voltage) classified output. The installer should properly size wiring and fusing for the input power and PT/CT circuits.

Discrete Inputs (Terminals 28–38)

Discrete inputs are the switch input commands to the 2301D control. They interact in such a way as to allow engine control and power management under a variety of conditions. Positive Voltage is supplied to the discrete input terminal when an input switch or relay contact closes. This will cause the input state for that discrete input to be “TRUE” (displayed as “CLOSED”). The input terminal will be open circuited when the input switch or relay contact opens. This will cause the input state for that discrete input to be “FALSE” (displayed as “OPEN”). When the input switch or relay contact is closed, the voltage supplying the discrete inputs should be present from the appropriate discrete input (terminal 31, 32, 33, 34, 35, 36, 37, or 38) to terminal 30 (common). Terminal 30 is the common return path for all of the discrete input channels. A lower voltage indicates that the switch contacts have too high a resistance when closed and should be replaced. These terminals must be isolated from ground.

In systems that provide an external low voltage source to power the 2301D control, the discrete inputs may be powered by this external low voltage. The voltage source used must be capable of supplying 100 mA at a voltage level of 18 to 40 Vdc. Connect the external low voltage source negative to terminal 30(–). Connect the external low voltage source positive to the appropriate input switch or relay contact and connect the mated switch or relay contact to the corresponding discrete input terminal on the 2301D control.

In systems where the external low voltage dc power is not appropriate, the discrete inputs may be powered by the internal 24 Vdc Discrete Input Power source at terminal 28 and 29. This source is capable of supplying 100 mA at a voltage level of 24 Vdc. Connect the internal 24 Vdc voltage source positive from terminal 28 to the appropriate input switch or relay contact, and connect the mated switch or relay contact to the corresponding discrete input terminal on the 2301D control. Assure that a connection exists between terminal 29 and terminal 30 when using the internal Discrete Input Power. Do not power other devices with the internal discrete input power source, and assure that the switch or relay contacts used are isolated from any other circuit or system.

IMPORTANT

Discrete inputs with cable lengths greater than 30 meters that are used for critical functions, such as emergency stop, should not be floated in either an on or off state. These inputs should be switched to +24 Vdc or ground.

Close to Run or Minimum Fuel (Terminal 31)

The external contact used to activate the Close to Run command connects to terminal 31. This discrete input changes the control operation by immediately decreasing the fuel demand to zero. When the switch or relay contacts are closed, the control is allowed to control the fuel in an attempt to control the speed/load of the prime mover. When the switch or relay contacts are open, the Minimum Fuel Function will immediately pull the fuel demand to zero.

WARNING

Do NOT use the minimum fuel contact as part of any emergency stop sequence.

Failed Speed Signal Override (Terminal 32)

A contact to override the failed speed signal circuit can be installed in series with terminal 32 and the dc power to the discrete inputs. When the contact is open, the control operates normally, turning the control output off in the event of a loss of speed signal. Closing the contact overrides the failed speed signal circuit as may be required for start-up. Prior to start-up of the prime mover, the speed signal is nonexistent. On prime movers with cranking motors, the cranking speed is usually sufficient to provide a speed signal, so an override contact on terminal 32 is not needed for starting. On some systems, the Failed Speed Signal Override contact must be closed in order to allow the actuator to open and provide fuel for starting. If a failed speed signal override contact is used, it should be of the momentary type to ensure that the failed speed sensor shutdown circuit is enabled after start-up.

Rated Speed (Terminal 33)

The external contact used to activate the Rated Speed command connects to terminal 33 (Discrete Input C). This discrete input changes the control operation by increasing the speed reference to RATED SPEED and decreasing the speed reference to IDLE SPEED. When the switch or relay contacts are closed, the speed reference will ramp for a time set by the Accel Time to the rated speed control point. When the switch or relay contacts are open, the speed reference will ramp for a time set by the Decel Time to the idle speed control point. The Idle Speed function is disabled by internal logic when the generator breaker is closed. The Rated Speed input should be left closed when the generator breaker is closed. If the application does not require an idle speed setting, the Rated Speed input can be left closed at all times. This can be done by connecting it directly to the positive Discrete Input Power source.

CB Aux/Droop Contact (Terminal 34)

The input switch or relay contact used to activate the Load Control connects to terminal 34. This discrete input is used to switch the control into isochronous mode, which allows the Load Control Function to operate. It is typically connected to an auxiliary contact on the generator circuit breaker. When the breaker closes, the input switch or relay contact should also close. When the external switch or relay contacts are open, the control will operate in Droop Mode. A switch in series with the auxiliary contact on the generator circuit breaker will allow manually selecting Droop Mode or Base Load/Isochronous Mode. Open this switch for Droop Mode. Close this switch for Base Load/Isochronous Modes.

When both the droop contact and circuit-breaker auxiliary contact are closed, the control is in the isochronous load-sharing mode (Figure 2-2). In this mode the internal load-sharing-line relay is energized, the droop signal is disabled permitting isochronous load sharing, and the load-matching circuit is connected to the load-sharing lines. The Generator Load contact at terminal 37 must be closed for isochronous load sharing, otherwise the generator load will be controlled at the unload trip level, and the internal relay will not energize to allow load sharing.

IMPORTANT

The control is in the droop mode whenever the circuit-breaker auxiliary contact is open. If a single prime mover is required to run isochronously with an isolated load, enter Load Droop Percent =0.0 when making *LOAD SETTING* adjustments.

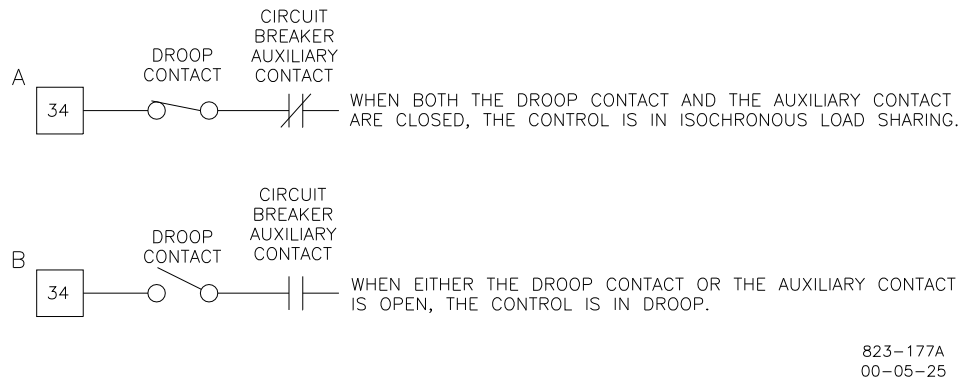

Figure 2-2. Droop Contact and Circuit Breaker Auxiliary Contact

Droop or Baseload operation is required when the generator is paralleled with an infinite bus without a Generator Loading Control, Process Control, Automatic Power Transfer and Load Control, Import/Export Control, or other load controlling accessory, or when paralleled with incompatible governors (all Woodward electric load-sharing systems are compatible). When running a single unit on an infinite bus with a Generator Loading Control or Import/Export Control, terminal 34 must be connected to terminal 28 to connect the Load Matching Circuit to the load-sharing lines. The load-sharing lines must be wired to the Generator Loading Control or Import/Export Control. The circuit-breaker auxiliary contact will then be connected to the Generator Loading Control or Import/Export Control and not to the 2301D Load Sharing And Speed Control.

This discrete input is used to change the control operation by selecting a second set of dynamic terms to be used when the input is closed. This command is normally used when the closed loop path needs two independent sets of dynamics. The dual dynamics control function is enabled by the Service menu item ENABLE DYNAMICS 2 W/CB.

Raise Speed/Load Contact (Terminal 35)

The input switch or relay contact used to activate the Raise Speed/Load command connects to terminal 35 (Discrete Input E). This discrete input changes the control operation by increasing the speed reference ramp when the CB Aux input at terminal 34 is open, and by increasing the base load reference when in base load mode. The speed reference ramp can increase only to a software adjusted RAISE SPEED limit. The base load reference ramp can increase only to a software adjusted BASE LOAD MAXIMUM limit. Both ramps increase at software adjusted rates. De-selecting the Rated Speed command (described above) takes command control away from the Raise Speed/Load input and effectively disables the command.

With the contacts open (discrete input in the "FALSE" state), the control will stop raising the speed or base load reference. Maintained simultaneous closure of this Raise Speed/Load contact along with the Lower Speed/Load contact enables the Remote Reference Input.

Lower Speed/Load Contact (Terminal 36)

The input switch or relay contact used to activate the Lower Speed/Load command connects to terminal 36 (Discrete Input F). This discrete input changes the control operation by decreasing the speed reference ramp when the CB Aux input at terminal 34 is open, and by decreasing the base load reference when in base load mode. The speed reference ramp can decrease only to a software adjusted LOWER SPEED limit. The base load reference ramp can decrease only to a software adjusted BASE LOAD MINIMUM limit. Both ramps decrease at a software adjusted rate. De-selecting the Rated Speed command (described above) takes command control away from Lower Speed/Load input and effectively disables the command.

With the contacts open (discrete input in the “FALSE” state), the control will stop lowering the speed or base load reference. Maintained simultaneous closure of this Lower Speed/Load contact along with the Raise Speed/Load contact enables the Remote Reference Input.

Load Generator (Terminal 37)

The input switch or relay contact used to activate the Load Generator command connects to terminal 37. This discrete input will cause the Load Control Function to ramp to a distinct mode of operation. If the state of the input is “TRUE”, the Load Control Function will increase or decrease in order to achieve either Isochronous Load Sharing or Base Load operation. If the state of the input is “FALSE” (input switch or relay contact open), the Load Control Function will increase or decrease in order to achieve the Unload trip level. The CB Aux/Droop Contact discrete input must be “TRUE” for the Load Generator input to affect the control.

Base Load (Terminal 38)

The input switch or relay contact used to activate the Base Load command connects to terminal 38. This discrete input will cause the Load Control Function to operate in Base Load. In this mode of operation the governor will control the load on the generator. The utility (main) bus or an isochronous generator set must control the bus frequency while in Base Load operation. With the state of this input “TRUE”, isochronous load sharing with other units is disabled. With the state of this contact “FALSE”, isochronous load sharing with other units can occur. The CB Aux/Droop Contact discrete input must be “TRUE” for the Base Load input to affect the control.

Actuator Output

The actuator wires connect to terminals 13(+) and 14(-). The current range to the actuator output is configured in software for a 0–200 mA or 0–20 mA actuator. The software configuration also allows for selection of Forward or Reverse acting actuator. Use shielded wires with the shield connected to terminal 15. Do not connect the shield to the actuator or any other point. The shield must have continuity the entire distance to the actuator, and must be insulated from all other conducting surfaces. Refer to the manuals listed in the “References” table for additional information on actuator installation.

Speed and Phase Matching (SPM) Synchronizer (Analog Input #1; Terminals 19-20)

Analog Input #1 is configured in software to accept a ± 2.5 V signal from a synchronizer. Connect the SPM Synchronizer (optional equipment) wires to Analog Input #1 terminals 19(+) and 20(-). Use shielded wire, and connect the shield to terminal 21. Make sure the shield has continuity the entire distance to the SPM Synchronizer, but do not connect the shield to the synchronizer. The shield must be insulated from all other conducting surfaces.

Remote Speed/Load Set Point/Auxiliary Input (Analog Input #2; Terminals 22-23)

Analog Input #2 is configured in software for any one of three choices, dependent on the application. Connect a Remote Speed or Load reference transmitter to Analog Input #2.

- The Remote Load set point moves the Load Ramp to the same value as the Remote Load set point, when the control is in Remote Base Load mode.
- The Remote Speed set point moves the Speed Ramp to the same value as the Remote Speed set point, when the control is in remote droop or isochronous mode.
- The Auxiliary input will bias the speed reference directly from an external device, such as a Woodward DSLC™ Digital Synchronizer and Load Control.

The input signal must be an isolated high quality signal representing the Remote Speed/Load set point. The Remote Speed/Load set point could be an operator adjusted potentiometer, a computer generated setting, etc. No connection is required to this input if this function is not needed by the application. The 2301D control is designed to receive either 0–20 mA, 4–20 mA, 0–5 Vdc, or 1–5 Vdc, representing a minimum Remote Speed/Load set point to a maximum Remote Speed/Load set point. Separate software minimum and maximum settings are provided for remote speed (rpm) and remote load (kW).

When the control is configured for operation with a DSLC control, the input is automatically set to accept the ± 2.5 Vdc output of the DSLC control.

Use a shielded twisted-pair cable to connect the Remote Speed/Load set point current transmitter to terminals 22(+) and 23(-). An input impedance of 250 Ω is present when the 2301D is configured for a current input. For a voltage input option, the input impedance will be greater than 10 M Ω . This input is not isolated from the other control inputs and outputs, and an isolation device must be installed if the transmitter output is not isolated.

Speed Sensor

Connect a speed-sensing device, such as a magnetic pickup, to terminals 25 and 26 using shielded wire. Connect the shield to terminal 27, making sure the shield has continuity the entire distance to the speed sensor, and that the shield is insulated from all other conducting surfaces.

Relay Driver Outputs (Terminals 41–44)

The 2301D contains four discrete output driver channels. The discrete outputs are low-side drivers with a maximum output current of 200 mA. The discrete output drivers are not isolated from each other, and are powered by an external +12 Vdc or +24 Vdc source connected at terminals 39(+) and 40(-). They are isolated from the internal power supplies of the 2301D control. The outputs are configured to provide two speed switches and two load switches.

Analog Output #1 (Terminals 16-17)

The analog output can be configured several different ways depending on the application needs. The output current is for either 0 to 20 mA or 4 to 20 mA. This current signal is supplied to terminals 16(+) and 17(-). Note that these terminals must be isolated from ground. The Output can be software configured to one of several control parameters. These parameters include:

- Engine Speed
- Engine Speed Reference
- Fuel Demand
- Generator Output
- System Load Percent
- Synchronizer Input
- Analog Input #2
- Speed Setting Bias Signal

The Analog Output is factory set for 4 to 20 mA, representing the engine speed. Default range is 0 to 100%. Software settings must be changed if an output of 0 to 20 mA is needed. Use shielded twisted-pair wires. For electrically isolated devices such as 4 to 20 mA analog meters, the shield should be grounded at the control end of the cable. For input to other devices, use the recommendation of the device manufacturer.

RS-232 Communication Port

The Communication Port is the DB9 female connector at the end of the front terminal strip. This port is used to monitor control inputs, outputs, and operating parameters. Control configuration changes and adjustments can also be made. The 2301D port is connected to a computer serial port, and the external computer software is used to display control parameters. The standard software used to communicate with the 2301D is Woodward Watch Window. This software can read all control parameters, and values. See Chapter 3 about control setup and also the Watch Window manual listed in the reference section.

IMPORTANT

The communication port must be connected with an approved jacketed serial communication cable. The connector must be secured to the 2301D to prevent contact with other circuits.

Installation Check-out Procedure

With the installation completed as described in this section, perform the following check-out procedure before beginning the start-up adjustments in Chapter 3.

1. Visual Inspection
 - A. Check the linkage between the actuator and the prime mover for looseness or binding. Refer to the appropriate actuator manual and to manual 25070, *Electric Governor Installation Guide*, for additional information on linkage.



The actuator lever should be near but not at the minimum position when the fuel or steam rack is at the minimum position. If the actuator lever gets to its minimum position before completely shutting off fuel or steam, the control may not be able to shut down the prime mover, causing damage to equipment or injury or death.

- B. Check for correct wiring in accordance with the plant wiring diagram, Figure 1-2.
- C. Check for broken terminals and loose terminal screws.
- D. Check the speed sensor for visible damage. Check the clearance of the magnetic pickup between the gear and the sensor, and adjust if necessary. Clearance should be between 0.25 and 1.0 mm (0.010 and 0.040 inch) at the closest point. Make sure the gear has less than 0.5 mm (0.020 inch) diametric runout. See manual 82510, *Magnetic Pickups and Proximity Switches for Electric Governors*.

Chapter 3.

Entering Control Set Points

Introduction

This chapter contains information on control calibration. It includes initial prestart-up and start-up settings and adjustments, and a current transformer phasing procedure. Because of the variety of installations, plus system and component tolerances, the 2301D control must be tuned and configured for each system to obtain optimum performance.

This chapter contains information on how to enter control set points through the control's menu system using the Watch Window software. See the next chapter for prestart-up and start-up settings and adjustments.



An improperly calibrated control could cause an overspeed or other damage to the prime mover. To prevent possible serious injury from an overspeeding prime mover, read this entire procedure before starting the prime mover.

Watch Window PC Interface

The connection of a computer is only required for calibration and setup of the 2301D control on a prime mover. The computer and Watch Window software is not required, and not necessary, for normal operation of the prime mover.

Watch Window was developed by Woodward to be a Servlink client software product that provides a generic PC interface to any control, and is a very powerful setup, testing, and troubleshooting tool. Watch Window provides a means of shutting down and placing the control in the I/O Lock mode for Configuration, saving values in the control EEPROM, and resetting the control. Application tunable values can be uploaded, downloaded, and saved to a file.

An "inspector" provides a window for real-time monitoring and editing of all control Configuration and Service Menu parameters and values. Custom "inspectors" can easily be created and saved. Each window can display up to 28 lines of monitoring and tuning parameters without scrolling. The number with scrolling is unlimited. Two windows can be open simultaneously to display up to 56 parameters without scrolling. Tunable values can be adjusted at the inspector window. Watch Window communicates with the control through an RS-232 cable connection to the comm port which is configured as a point-to-point only Servlink Server.

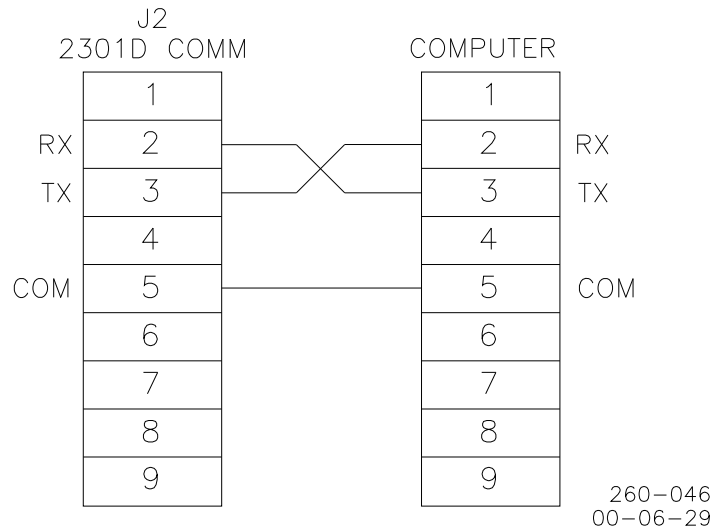

The drawing above shows the required connections in the null modem cable. These are the minimum connections, some purchased null modem cables have more interconnects, which are not used by the control.

The 2301D default baud rate is 38400, which needs to be entered in the Servlink Network Options window. Servlink will be initialized correctly for all other port parameters except BAUD rate.

Check the 'pull-down' menu CONTROL \ PROPERTIES to display the part number and revision level of the software in the control. Refer to this number and revision level in any correspondence with Woodward (write this information in the programming checklist, Appendix D). The Watch Window software has extensive help assistance through the Help Menu.



Watch Window version 1.05 and above allows for automatic generation of inspector sheets. Click on the **Q** icon (Quick Inspector) on the tool bar. A Sheet will automatically be created for each Service and Configure Header programmed into the control. Multiple inspectors can be created this way to allow for viewing more than one sheet at a time.



To enter the **I/O Lock** mode and enable a configure value to be entered, click on the I/O Lock icon on the Tool Bar. Because the values set in Configure are critical to engine operation, it is not safe to operate the prime mover while these parameters are being configured. In the Configure mode the control outputs will be set to their off state, and the microprocessor will stop executing the application code. The control will have to be Reset to continue operation.



The **Reset** icon allows the microprocessor to store the configure parameters, to return the outputs to their active state, and to resume executing the application software.



When the tuning or setting of parameters is complete, the values must be saved in the control's non-volatile memory. Go to the Tool Bar and click the PROM icon for **Save Values**. The values will be saved in non-volatile memory and will be unaffected by loss of power to the control.



If an application configuration has been previously saved to a *.CFG file, the saved set of parameters can be loaded into the 2301D as a group by selecting the **Load Application Settings** icon.



To save the configuration to a file in the external computer for backup or download later into another 2301D when a similar system is being set up, select the **Save Application Settings** icon. All the tunable values presently set in the control will be saved to a file and can be loaded into this 2301D control to reprogram it to the saved values or into another 2301D at a later time.

Configure Menu Descriptions

CONFIGURE: INPUT AND OUTPUT OPTIONS

- 01 REVERSE ACTING ACTUATOR** should be set to TRUE for reverse acting actuators and FALSE for forward acting actuators (default is FALSE). Forward acting actuators require increase current to increase fuel. Reverse acting actuators require decrease current to increase fuel (reverse-acting actuators should always incorporate a mechanical ballhead backup governor, such as the Woodward EGB).
- 02 ACT OUTPUT TYPE (1,2,3)**, select current range of actuator used. Should be set to:
 - 1 = 0–200 mA actuator
 - 2 = 0–20 mA actuator
 - 3 = 4–20 mA actuator
- 03 RMT INPUT #2 IS SPEED REF**, set to TRUE if input at terminals 22, 23, and 24 are to be used to vary the speed reference from an external 4-20 mA device. Otherwise leave FALSE.
- 04 RMT INPUT #2 IS BASELOAD REF**, set to TRUE if input at terminals 22, 23, and 24 are to be used to vary the base load reference from an external 4-20 mA device. Otherwise leave FALSE.
- 05 SEL REF IN TYPE/RNG (1-4)**, select type and range of input #2 when used as a speed or load reference. If input #2 is an Aux (DSLCL) input, this value is not used. The input should be set to:
 - 1 = 4–20 mA input
 - 2 = 0–20 mA input
 - 3 = 0–5 Volt input
 - 4 = 1–5 Volt input
- 06 RMT INPUT #2 AUX (DSLCL) IN**, set to TRUE if input at terminals 22, 23, and 24 are to be used to vary the speed reference from a Woodward Digital Synchronizer and Load Control (or other similar device). Otherwise leave FALSE. If input is used as an Aux input the input type/range is automatically configured as a ± 2.5 volt type input.

- 07 CB OPEN RELAY NORM ENGZD**, the discrete output at terminal 44 is used to give a momentary output that can be used to automatically open the circuit breaker when the generator has unloaded. The control will be configured for the driver to be normally energized and momentarily de-energize (TRUE) when the generator load is at the unload trip level. Set to FALSE and the output will energize momentarily when the generator load drops to the unload trip level.

CONFIGURE: ENGINE & SPEED CONTROL

- 01 ENTER RATED (RPM)**, set to the rated synchronous rpm of the engine/generator. This will typically be a value from the following table:

Generator Poles	60 Hz Generator	50 Hz Generator
2	3600 rpm	3000 rpm
4	1800 rpm	1500 rpm
6	1200 rpm	1000 rpm
8	900 rpm	————

This value will be used to set the 2301D speed sensor hardware to software conversion. The rated speed can be varied in Service for testing. If a Rated speed other than values listed here is entered, the calculated generator frequency shown in **** DISPLAY MENU **** may not be correct.

- 02 ENTER NUMBER OF GEAR TEETH** is the number of teeth or holes of the gear or flywheel that the speed sensor is on. If the gear is on the cam shaft or other drive not at prime mover speed the number of teeth needs to be adjusted to compensate. EXAMPLE: If the gear is rotating at one-half the engine speed enter one-half the number of actual teeth.

IMPORTANT

The maximum input frequency that can be measured by the speed sensing circuit is 25 000 Hz. Therefore to allow for transient conditions, the Number of Teeth times Rated RPM divided by 60 should be less than 19 000.

WARNING

The number of gear teeth is used by the control to convert pulses from the speed-sensing device to engine rpm. To prevent possible serious injury from an overspeeding engine, make sure the control is properly programmed to convert the gear-tooth count into engine rpm. Improper conversion could cause engine overspeed.

- 03 ENTER FAILED SPD SENSE %** should be set to a percentage of rated prime mover speed that will verify a valid MPU signal exists while the prime mover is starting. (default is 5% of rated).
- 04 USE START SPEED** should be set to TRUE to enable a tunable Start Speed Reference. Set to FALSE to disable the Start Speed Reference. This is typically only used on gas engines to allow speed control below idle speed and to allow acceleration to the Start Fuel Limiter without over fueling.
- 05 ENABLE 5 SLOPE GAIN MAP** should be set TRUE to permit the use of a 5-Gain Curve for setting the control gain as a function of prime mover load. If "Use 2nd Dynamics" is also set TRUE, the use of a second 5-Gain Curve is activated. These two curves each provide 5 tunable gain settings at 5 tunable load dependent breakpoints. If 'Enable 5 Slope Gain Map' is set FALSE only a single gain value will be used as the dynamic adjustment.

- 06 5 SLOPE GAINLOAD IS KW%** should be set to TRUE to select the 5-slope gain map load axis to be based on percent generator load (KW). Set to FALSE to make slope breakpoints dependent on percent engine fuel demand.
- 07 ENTER THE MAX/RATED LOAD (KW)** is the maximum load (in kilowatts) of the generator. This value will limit the ENTER RATED LOAD (KW), H** LOAD SETTINGS **sheet.

Service Menu Descriptions

A**Dynamics #1 **

Dynamic adjustments are settings that affect the stability and transient performance of the engine. There are two sets of dynamics provided. To disable the second set of dynamic go to B** DYNAMICS 2 ** and set the first prompt (Enable Dynamics 2 w/CB) to FALSE. The Dynamics being used for control is selected by the CB Aux contact input. The control uses the 1st dynamics when the CB Aux contact input is open, and it uses the 2nd dynamics when the contact is closed.

- 01 PROP GAIN 1** determines how fast the control responds to an error in engine speed from the speed-reference setting. The Gain is set to provide stable control of the engine at light or unloaded conditions.
- 02 RESET 1** compensates for the lag time of the engine. It adjusts the time required for the control to return the speed to zero error after a disturbance. Reset is adjusted to prevent slow hunting and to minimize speed overshoot after a load disturbance.
- 03 ACTUATOR COMPENSATION 1** compensates for the actuator and fuel system time constant. Increasing Compensation increases actuator activity and transient performance.
- 04 WINDOW WIDTH 1 (RPM)** is the magnitude (in rpm) of speed error at which the control automatically switches to fast response. The control uses the absolute value of speed error to make this switch. The absolute value is the difference between the speed reference and the speed. A Window Width too narrow will result in cycling that always factors in the Gain Ratio (see Figure 3-1).
- 05 GAIN RATIO 1** is the ratio of the Gain setting at steady state to the Gain setting during transient conditions. The Gain Ratio operates in conjunction with the Window Width and Gain adjustments by multiplying the Gain set point by the Gain Ratio when the speed error is greater than the Window Width. This makes the control dynamics fast enough to minimize engine-speed overshoot on start-up and to reduce the magnitude of speed error when loads are changing. This allows a lower gain at steady state for better stability and reduced steady-state actuator linkage movement (see Figure 3-1).

DUAL GAIN DYNAMICS SPEED CONTROL

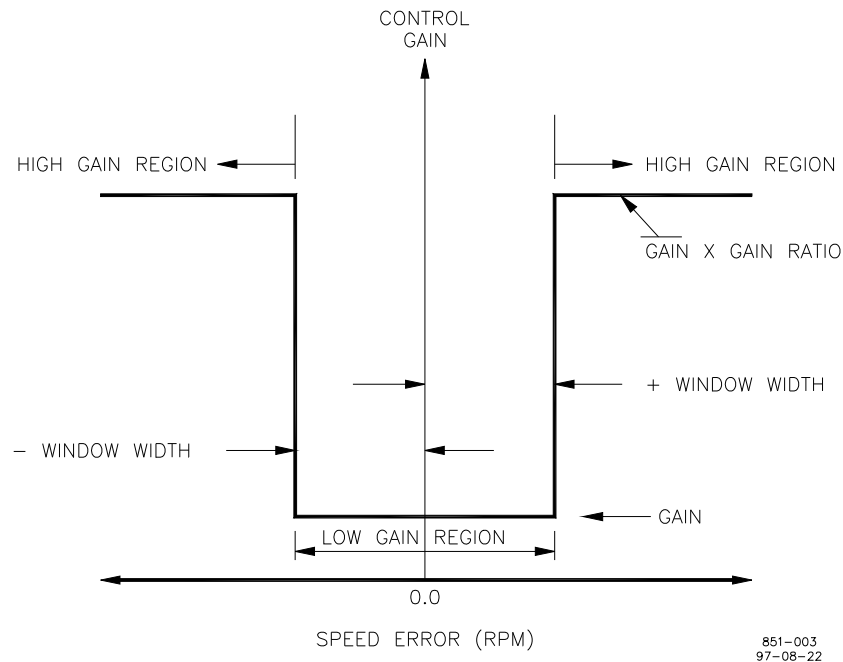

Figure 3-1. Control Gain as a Function of Speed Error

- 06 SPEED FILTER FREQ 1 (HZ)** adjusts the cutoff frequency of a low pass filter used on the engine speed sensing input (see Figure 3-2). To use this feature set the cutoff frequency below 15.9 Hz. The filter is used to attenuate engine firing frequencies. To calculate the desired filter cutoff point, use the following formulas:

$$\begin{aligned} \text{camshaft frequency} &= (\text{engine rpm})/60 \text{ [for 2-cycle engines]} \\ &= (\text{engine rpm})/120 \text{ [for 4-cycle engines]} \end{aligned}$$

$$\text{firing frequency} = \text{camshaft frequency} \times \text{number of cylinders}$$

Initially set the filter frequency to the firing frequency.

As the filter frequency is reduced, steady state stability improves but transient performance may worsen. As the filter frequency is increased, steady state stability worsens but transient performance may improve.

IMPORTANT

If the calculated firing frequency is greater than 15.9 Hz, then disable the filter by setting the filter cutoff frequency at or above 15.9 Hz.

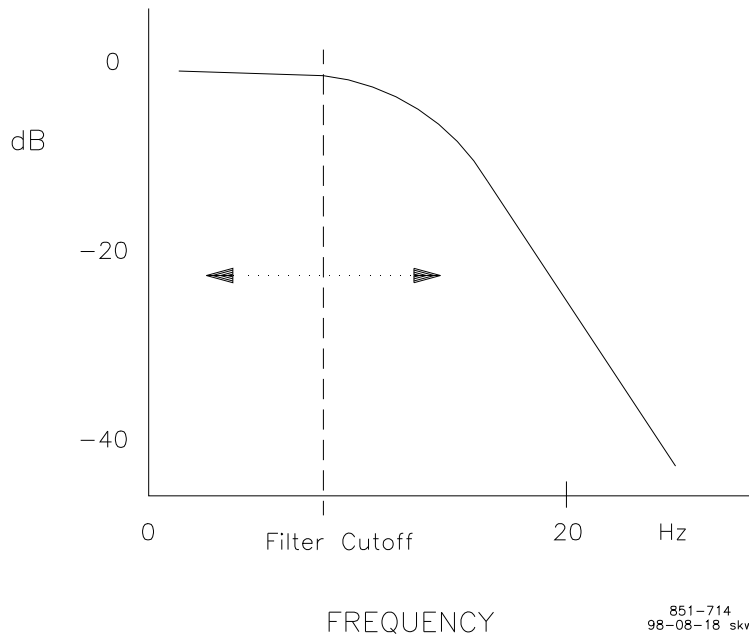

Figure 3-2. Speed Filter

07 BUMP ACT TRIGGER (T THEN F) allows you to test your dynamics settings by temporarily applying a decreased fuel demand transient to stimulate a control response. Both the magnitude (Act Bump Level) and duration (Act Bump Duration) of the transient may be set. The actuator bump must be enabled in the ACTUATOR BUMP menu. To initiate an actuator bump, toggle Bump Act to TRUE then back to FALSE while the engine is operating in a normal steady state loaded or unloaded condition.

Figure 3-3 illustrates prime mover starts with the RAMP TIME set to minimum (no ramp), step loadings at four different RESET settings, and stable, steady-state running conditions. These are typical performance curves on a naturally aspirated (non-turbocharged) diesel engine.

IMPORTANT

Optimum performance is not necessarily obtained with the GAIN set to maximum (stable). In some cases, the gain must be reduced slightly to ensure stability under widely varying conditions.

IMPORTANT

Be prepared to change the dynamics settings since the actuator bump transient may stimulate instability.

IMPORTANT

BUMP ENABLE must be set TRUE to enable the BUMP ACT function. See the ACTUATOR BUMP SETUP menu.

RESULTS — GAIN AND RESET ADJUSTMENTS

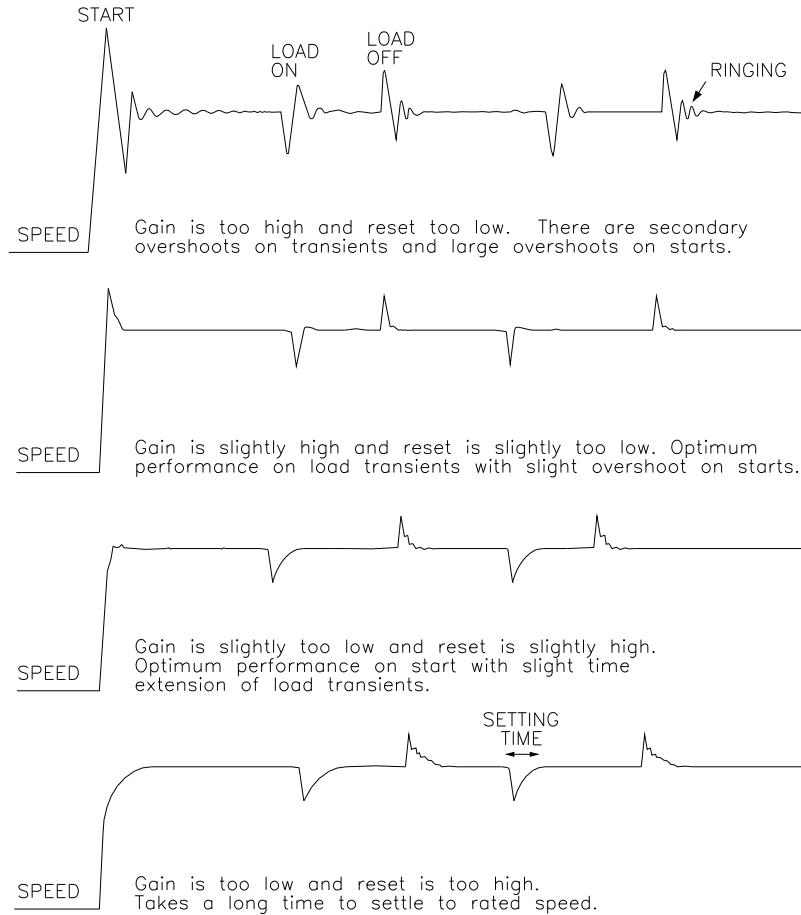

IDEAL LOAD STEP RESPONSE

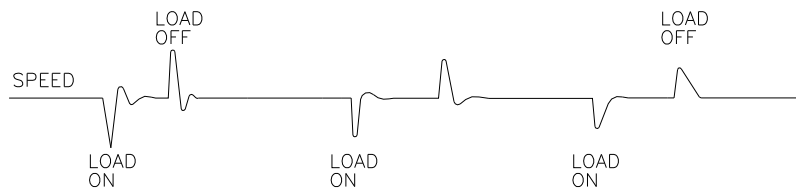

RESULTS — COMPENSATION ADJUSTMENT

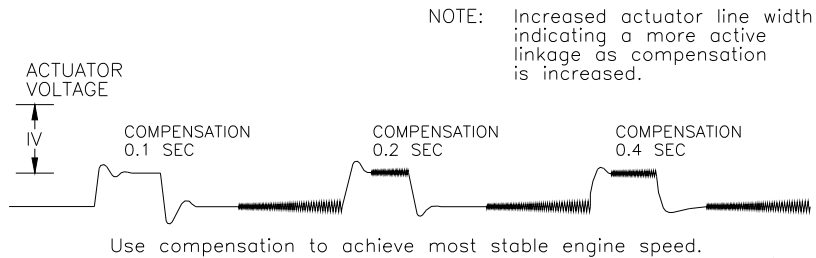

851-004c
97-12-19 skw

Figure 3-3. Typical Transient Response Curves

BDynamics #2****

The Dynamics 2 control parameters are adjusted the same as Dynamics 1 described above. To enable the use of two sets of dynamics, it is necessary to set Enable 2nd DYNAMICS w/CB below to TRUE. These parameters are in control only when the CB Aux contact input is closed.

- 01 ENABLE DYNAMICS 2 W/CB**, when TRUE, the second set of dynamics will be enabled when the Circuit Breaker Auxiliary contact at terminal 34 is closed. When this prompt is FALSE, only Dynamics 1 will be used to set speed control response.
- 02 DELAY DYN2 ENABLE (SEC)=**, is a delay time, in seconds, that dynamics #1 will continue to be used by the speed control after the CB contact at terminal 34 is closed.
- 03 DELAY DYN1 ENABLE (SEC)=**, is the delay time that dynamics #2 will continue to be used before switching to dynamics #1.
- 04 PROP GAIN 2**
- 05 RESET 2**
- 06 ACTUATOR COMPENSATION 2**
- 07 WINDOW WIDTH 2**
- 08 GAIN RATIO 2**
- 09 SPEED FILTER FREQ 2**
- 10 BUMP ACT TRIGGER (T THEN F)**

Items 04 through 10 will have the same effect on speed control response as Dynamics #1 described above.

C Dynamics #1 5 Pt Gain****

This menu and control function is enabled when CONFIGURE: ENGINE & SPEED CONTROL 'ENABLE 5 SLOPE GAIN MAP' is TRUE and provides a 5-point curve as a function of prime mover load for the variable GAIN set point. The Breakpoint parameter is based on what is set in Configure: '5 Slope Gain Load is KW%'. The prime mover Fuel Demand % (FALSE) or generator Kilowatt % (TRUE) is used as the load axis. It is useful in applications that have a non-linear fuel valve (such as butterfly valves). A plot of the fuel system must be determined to properly adjust the gain of the control to match the gain of the system at all loads. See the Gas Engine setup and Control gain programming steps sections below.

- 01 BREAKPOINT 1A (%LD)**, is set at the min load point no-load fuel demand or 0% KW.
- 02 GAIN @BREAKPOINT 1A** is the no load GAIN value.
- 03 BREAKPOINT 1B (%LD)** is the Fuel demand % or KW% at the next load breakpoint.
- 04 GAIN @BREAKPOINT 1B** is the GAIN value when the load is at breakpoint B.
- 05 BREAKPOINT 1C (%LD)**, load % for breakpoint C.
- 06 GAIN @BREAKPOINT 1C** is the GAIN value when the load is at breakpoint C.
- 07 BREAKPOINT 1D (%LD)**, load % for breakpoint D.
- 08 GAIN @BREAKPOINT 1D** is the GAIN value when the load is at breakpoint D.
- 09 BREAKPOINT 1E (%LD)**, load % for breakpoint E.
- 10 GAIN @BREAKPOINT 1E** is the GAIN value when the load is at breakpoint E.

- 11 RESET 1** compensates for the lag time of the engine. It adjusts the time required for the control to return the speed to zero error after a disturbance. Reset is adjusted to prevent slow hunting and to minimize speed overshoot after a load disturbance.
- 12 ACTUATOR COMPENSATION 1** compensates for the actuator and fuel system time constant. Increasing Compensation increases actuator activity and transient performance.
- 13 WINDOW WIDTH 1 (RPM)** is the magnitude (in rpm) of speed error at which the control automatically switches to fast response. The control uses the absolute value of speed error to make this switch. The absolute value is the difference between the speed reference and the speed. A Window Width too narrow will result in cycling that always factors in the Gain Ratio (see Figure 3-1).
- 14 GAIN RATIO 1** is the ratio of the Gain setting at steady state to the Gain setting during transient conditions. The Gain Ratio operates in conjunction with the Window Width and Gain adjustments by multiplying the Gain set point by the Gain Ratio when the speed error is greater than the Window Width. This makes the control dynamics fast enough to minimize engine-speed overshoot on start-up and to reduce the magnitude of speed error when loads are changing. This allows a lower gain at steady state for better stability and reduced steady-state actuator linkage movement (see Figure 3-1).
- 15 SPEED FILTER FREQ 1 (HZ)** adjusts the cutoff frequency of a low pass filter used on the engine speed sensing input (see Figure 3-2). To use this feature set the cutoff frequency below 15.9 Hz. The filter is used to attenuate engine firing frequencies. To calculate the desired filter cutoff point, use the following formulas:

$$\begin{aligned} \text{camshaft frequency} &= (\text{engine rpm})/60 \text{ [for 2-cycle engines]} \\ &= (\text{engine rpm})/120 \text{ [for 4-cycle engines]} \\ \text{firing frequency} &= \text{camshaft frequency} \times \text{number of cylinders} \end{aligned}$$

Initially set the filter frequency to the firing frequency.

As the filter frequency is reduced, steady state stability improves but transient performance may worsen. As the filter frequency is increased, steady state stability worsens but transient performance may improve.

IMPORTANT

If the calculated firing frequency is greater than 15.9 Hz, then disable the filter by setting the filter cutoff frequency at or above 15.9 Hz.

- 16 BUMP ACT TRIG (T THEN F)** allows you to test your dynamics settings by temporarily applying a decreased fuel demand transient to stimulate a control response. Both the magnitude (Act Bump Level) and duration (Act Bump Duration) of the transient may be set. The actuator bump must be enabled in the ACTUATOR BUMP SETUP menu. To initiate an actuator bump, toggle Bump Act to TRUE then back to FALSE while the engine is operating in a normal steady state loaded or unloaded condition.

D** Dynamics #2 5 Pt Gain **

The Dynamics 2 control parameters are adjusted the same as Dynamics 1 described above. These parameters are in control only when the CB Aux contact input is closed.

- 01 **ENABLE DYNAMICS 2 W/CB** when TRUE, the second set of dynamics will be enabled when the Circuit Breaker Auxiliary contact at terminal 34 is closed. When this prompt is FALSE, only Dynamics 1 will be used to set speed control response.
- 02 **DELAY DYN 2 ENABLE (SEC)** is a delay time, in seconds, that dynamics #1 will continue to be used by the speed control after the CB contact.
- 03 **DELAY DYN 1 ENABLE (SEC)** is the delay time that dynamics #2 will continue to be used before switching to dynamics #1.
- 04 **BREAKPOINT 2A (%LD)**
- 05 **GAIN @BREAKPOINT 2A**
- 06 **BREAKPOINT 2B (%LD)**
- 07 **GAIN @BREAKPOINT 2B**
- 08 **BREAKPOINT 2C (%LD)**
- 09 **GAIN @BREAKPOINT 2C**
- 10 **BREAKPOINT 2D (%LD)**
- 11 **GAIN BREAKPOINT 2D**
- 12 **BREAKPOINT 2E (%LD)**
- 13 **GAIN BREAKPOINT 2E**
- 14 **RESET 2**
- 15 **ACTUATOR COMPENSATION 2**
- 16 **WINDOW WIDTH 2 (RPM)**
- 17 **GAIN RATIO 2**
- 18 **SPEED FILTER FREQ 2 (HZ)**
- 19 **BUMP ACT TRIG (T THEN F)**

Items 04 through 19 will have the same effect on speed control response as **Dynamics #1, 5 pt Gain** described above.

Gas Engine Setup

The butterfly valve position of a gas engine is not linear in comparison to engine power output. In naturally-aspirated (non-turbocharged) engines, the position of the valve in comparison to engine output appears on a chart similar to Figure 3-4.

Turbocharged engines distort this curve, particularly as turbo pressure builds to the point of operating the waste gate. A turbocharged gas engine will likely have a butterfly position chart similar to Figure 3-5.

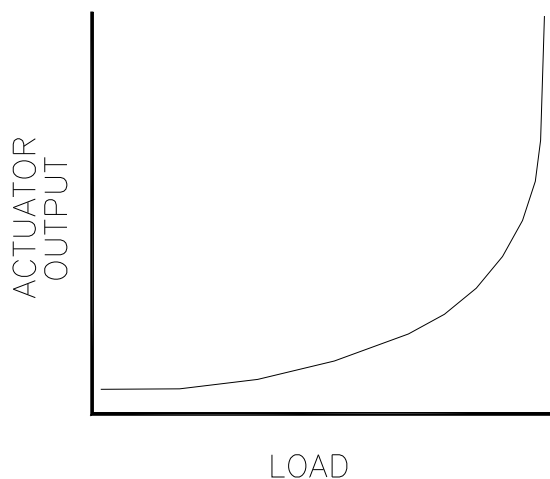

041-090
93-4-8 RAM

Figure 3-4. Non-linear Valve Power Curve

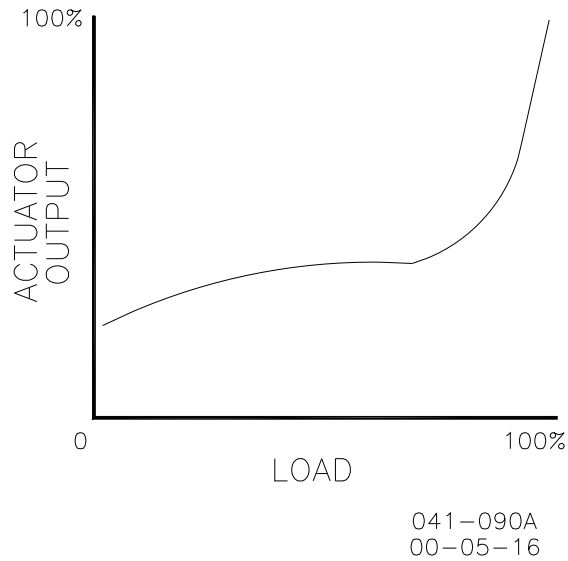

Figure 3-5. Sample Engine Plot

Note in both charts that valve position falls on a curve. The menu does not permit the construction of a curve. However, with four slope segments (5 break points) available, a rough approximation of the curve can be created (see Figure 3-6).

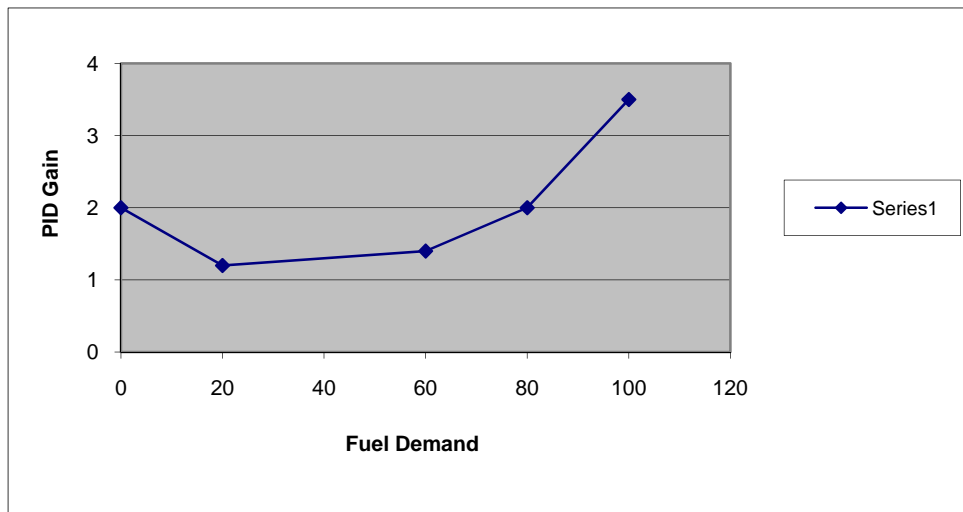

Figure 3-6. Linearized Gain Plot

Diesel Engine Setup

Most Diesel engine fuel controls are nearly linear. The dynamics maps may still be used to accommodate nonlinear conditions caused either by the fuel system or by linkage between the actuator and the rack. For gain settings that are not used, set the associated Breakpoint at 100%.

Control Gain Programming Steps

1. Gain programming is needed whenever the gain of the engine and fuel system is non-linear. This usually occurs in gas engine applications. A plot of the fuel system must be determined to properly adjust the gain of the control to match the gain of the system at all loads.

The plot reflects the actuator output, as seen in P**DISPLAY MENU**, versus the engine load as load is varied from no load to full load.

To construct a gain plot:

- a. Set the Gain A breakpoint for 100%. This ensures that there won't be any confusion with other settings while plotting the system characteristics. Only Gain A, Reset, and Actuator Compensation will be used.
- b. Start the engine and obtain good control at no load using Gain A, Stability, and Actuator Compensation. Record these settings and the actuator output as displayed in P**DISPLAY MENU**.
- c. Load the engine with as many load points as are practical. At each load point, Gain A may need to be varied to maintain engine stability. Do not change Reset or Actuator Compensation after the first setting in step b. Should it be necessary to change these settings to obtain good control, repeat all previous steps until only Gain is changed at each load step. At each load point, record the Fuel Demand % that is displayed in P**DISPLAY MENU**. Also record the engine load (KW) and Gain A at each point. If KW percent is selected for the X axis of the curve, the ratio of KW to Rated KW times 100 will be used as the load percent value. The actuator bump feature can be used to make small fuel changes about the load point to verify stability.

The table below aids in collecting the data for the Gain Plot. When entering the values into the control, the software will not allow overlapping the breakpoint values (that is, Breakpoint A must be less than breakpoint B, which must be less than breakpoint C, etc).

Gain settings reflect the sensitivity of the engine load to fuel demand as shown in Figure 3-5. Flat portions of the engine plot will require relatively small values of gain, steep portions of the plot will require larger gain numbers (actuator has to move a lot to pickup small amount of load).

- d. Create a plot of the system by plotting PID GAIN as a function of load. A typical result is shown in Figure 3-6.

The following table may help in the construction of the plot. Use as many load steps as possible, it is not necessary to use all 20 points given below.

Load Point	Gain (for good control)	Actuator or kW Output
Load Point 1		
Load Point 2		
Load Point 3		
Load Point 4		
Load Point 5		
Load Point 6		
Load Point 7		
Load Point 8		
Load Point 9		
Load Point 10		
Load Point 11		
Load Point 12		
Load Point 13		
Load Point 14		
Load Point 15		
Load Point 16		
Load Point 17		
Load Point 18		
Load Point 19		
Load Point 20		

2. Set Gain A to the value recorded at point 1b. This should give good control at no load.
3. Use the plot of the engine to determine the linearity of the fuel system. This curve should be linearized between inflection points as shown in Figure 3-6.
4. Set the Gain A Breakpoint for the actuator output at or slightly below the load value at the min load point. Set the GAIN value at breakpoint A.
5. Set the Gain B Breakpoint at the point slightly above the first inflection point in the load plot. Gain B should now be adjusted to obtain good control at the inflection point B. Note: you may already have obtained the correct value in Step 1c.

WARNING

Be prepared to change the dynamics settings since the actuator bump transient may stimulate instability, which could result in an overspeed condition.

IMPORTANT

BUMP ENABLE must be set to TRUE to enable the BUMP ACT function. See the ACTUATOR BUMP menu.

E** Actuator Bump Setup **

- 01 **BUMP ENABLED** is set to TRUE to enable the actuator bump for 60 minutes. Set to FALSE to disable this function. When this prompt is set FALSE, the Actuator Bump tunable in the Dynamics sections described above is disabled.
- 02 **ACT BUMP LEVEL (%FD)** is set in % fuel demand for the desired bump level.
- 03 **ACT BUMP DURATION (SEC)** is set in seconds for the desired bump duration.
- 04 **BUMP ACT TRIGGER (T THEN F)** allows you to test your dynamic settings by temporarily applying a decrease fuel demand transient to stimulate a control response. To initiate an actuator bump, toggle Bump Act to TRUE then back to FALSE while the engine is operating in a normal steady state loaded or unloaded condition.

F** FUEL LIMITERS **

Fuel limiters restrain the fuel demand from the control to the actuator.

- 01 **START FUEL LIMIT (%FD)** limits the percent fuel demand when the engine is started. The limit is usually set at the fuel level required to start the engine. The limiter is disabled when the engine fuel is controlled by speed (see Figure 3-4). The limiter begins out of the way at 100% with no speed. Upon speed exceeding the Failed speed sense percent, the START FUEL LIMIT immediately limits the fuel to the start fuel limit level. The limiter then ramps at START RAMP RATE (%FD/S) until the speed has reached 95% of reference and the Speed Control PID is in control for 1 second.

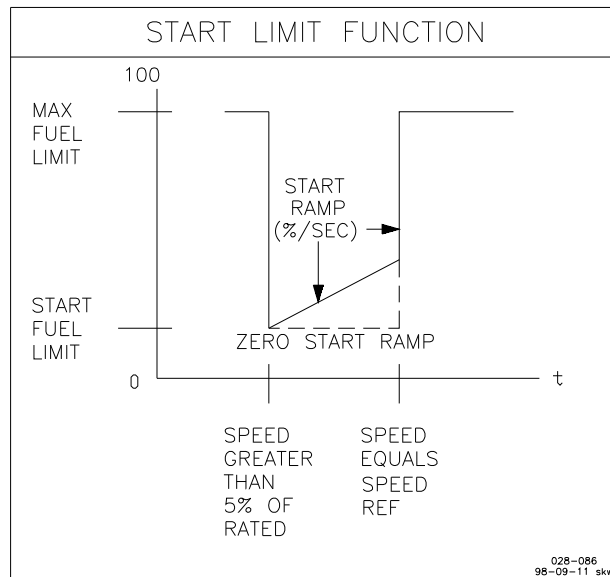

Figure 3-7. Start Limit Function

- 02 **START RAMP (%FD/S)** establishes the start limiter ramping rate at which the fuel demand increases to assist starting in colder ambient conditions.
- 03 **MAX FUEL LIMIT (%FD)** sets the maximum percent fuel demand. Maximum (100%) is based on 200 mA. This is an electronic rack stop which is active in all modes of operation.

GSPEED SETTINGS ****

Speed Settings are the parameters that affect the prime mover speed reference.

- 01 RATED SPEED (RPM)** is the speed the prime mover will ramp to when the Idle/Rated switch is closed. It is normally the same value as entered in Configure setting as the Rated speed. If the rated speed needs to be adjusted for test or specific operation, this is the value the should change.
- 02 START SPEED (RPM)** is the initial speed reference for the speed control prior to starting. Start Speed must be set above cranking speed and below the speed achieved with the start fuel limit setting (light-off speed). A ramp from the Start Speed to idle or rated, whichever is selected, begins when the engine accelerates to Start Speed. The ramp time is the accel ramp time setting, when going to the rated speed set point. The ramp time is the decel ramp time setting, when going to the idle speed set point.
- 03 RAISE SPEED LIMIT (RPM)** is the maximum speed reference setting when the Raise Switch is Closed. It normally is set at the speed at which the engine operates at full load if the Droop mode is used or the high limit of the speed trim function.
- 04 LOWER SPEED LIMIT (RPM)** is the minimum speed reference setting when the Lower Switch is Closed. It normally is set at the minimum operating speed of the engine or the minimum limit of the speed trim function.
- 05 IDLE SPEED (RPM)** is the speed that the speed reference ramp goes to when the Close for Rated Discrete Input is OPEN. It is normally the speed at which the engine is operated at start-up. It is also used during cool down.

IMPORTANT

Idle Speeds is limited to a value between Synchronous speed entered in configure and 20% of synchronous speed. (a 5 to 1 speed range).

NOTICE

Be sure to avoid critical speeds when setting idle speed.

- 06 ACCEL RAMP TIME (SEC)** is the time required for the control to ramp the engine speed from Idle speed to Rated speed. The ramp is started whenever the Idle/Rated contact is closed.
- 07 DECEL RAMP TIME (SEC)** is the time required for the control to ramp the engine speed from Rated speed to Idle speed. The ramp is started whenever the Idle/Rated contact is opened.

IMPORTANT

Actual engine deceleration may be slower than set by the Decel Ramp Time set point. This occurs when the Decel Ramp Time set point is faster than the amount of time that system inertias allow the engine to slow down. This condition is indicated by the control actuator output going to the minimum fuel position.

- 08 SPEED TRIM INC TIME (SEC)** is the time for the speed reference to ramp from the Lower Speed Limit to the Raise Speed Limit when using the Raise Speed switch input.
- 09 SPEED TRIM DEC TIME (SEC)** is the time for the speed reference to ramp from the Raise Speed Limit to the Lower Speed Limit when using the Lower Speed switch input.

H** LOAD SETTINGS **

The load Setting section is the set-up of the generator load control parameters.

- 01 ENTER RATED LOAD (KW)** is the rated (maximum) load (in Kilowatts) of the generator. This value is used to calculate full engine/generator load that will give the entered load gain value. This value is limited by the ENTER RATED/MAX LOAD (KW) in Configure Engine and Speed Control sheet.
- 02 LOAD DROOP PERCENT** is the percentage of rated speed the speed reference will droop when the generator load is increased to maximum load. Set to desired droop percent.
- 03 LOAD GAIN VOLTAGE**—Enter the load gain desired at 100% load. The software will use the Rated KW value above and this Load Gain voltage value to scale the analog output to the load sharing circuitry to perform load sharing with other controls in the system. A value of 6.0 is usually sufficient to allow load sharing with other units utilizing 0–3 Vdc analog load sharing lines. If derated load operation is needed, set the value higher than the other units. This value must be common with all other controls connected to the common Load Sharing Signal lines.
- 04 BASE LOAD MINIMUM (KW)** is the minimum value the base load reference will ramp to when the external lower switch at terminal 36 is closed.
- 05 BASE LOAD REFERENCE (KW)** Enter the internal Baseload set point. This sets the initial internal set point of the Baseload Reference Ramp when the Load Control enters Base Load mode.
- 06 BASE LOAD MAXIMUM (KW)** is the maximum value the base load reference will ramp to when the external raise switch at terminal 35 is closed.
- 07 BASELOAD RAISE TIME (SEC)** is the time for the reference to ramp from baseload minimum to baseload load maximum values entered above.
- 08 BASELOAD LOWER TIME (SEC)** is the time for the reference to ramp from baseload maximum to baseload load minimum values entered above.
- 09 UNLOAD TRIP LEVEL (KW)**—Enter the unload trip level set point. This sets the load level that the unit unloads to following an Unload command. When the Load switch is opened to unload, the generator unloads to this KW value. The Discrete output 4 will then change state momentarily to give a breaker open command.
- 10 LOADING RATE (KW/SEC)**—Enter the loading rate. This sets the rate at which the Load Ramp will increase for soft loading.
- 11 UNLOADING RATE (KW/SEC)**—Enter the unloading rate. This sets the rate at which the Load Ramp will decrease for soft unloading.
- 12 ENABLE FAST LOAD RATE**—Set to TRUE if the function to activate a faster loading ramp rate than the LOADING RATE entered above when the system load level is high.
- 13 FAST RAMP ENABLE LOAD (%)**—When the system load, as measured through the load sharing lines, is determined to be above this percentage the soft load ramp rate will switch to a faster rate to allow this oncoming unit to pick up its share of the load faster.
- 14 FAST RAMP RATE (KW/SEC)**—Enter the loading rate at which the load will increase when the system load is above the percentage entered above.

I ANALOG INPUTS SETTINGS ****

This group of Service sets the parameters of the two analog inputs at terminals 19 through 24.

- 01 AI 2 CONFIGURED FOR**—This will display the function Analog Input #2 at terminal 22–24 was set for in the Configure mode. Only the parameters below that relate to this displayed function are used by the control.
- 02 ANIN #2, INPUT TYPE**—This will display one of the following string to indicate the input range selected for input 2:
 - ±2.5 V
 - 4–20 mA
 - 0–20 mA
 - 0–5 V
 - 1–5 V
- 03 ANIN #2 (UNITS)**—The units of the input type above (volts or mA) are the units of the Analog Input #2 value displayed here.
- 04 SPEED W/ RMT@4MIN (RPM)**—Set the speed reference value when the remote reference input is at the low value for the selected range. This value may be less than or greater than the value entered when the input is at maximum.
- 05 SPEED W/ RMT IN@MAX (RPM)**—Set the speed reference value when the remote reference input is at the maximum value for the selected range.
- 06 RMT SPEED REF INPUT (RPM)** displays the speed reference based on analog input #2. **NOTE:** this displayed value is the result of the input parameter, it is not limited by the ramp times or switch input logic.
- 07 RMT SPDREF INC TIME(SEC)**—Set the time for the speed reference to ramp from the 4 mA speed setting to the 20 mA speed setting.
- 08 RMT SPDREF DEC TIME(SEC)**—Set the time for the speed reference to ramp from the 20 mA speed setting to the 4 mA speed setting.
- 09 BSLOAD W/RMT IN@MIN (KW)**—Set the Base Load reference value when the remote reference input is at the low value for the selected range. This value may be less than or greater than the value entered when the input is at maximum.
- 10 BSLOAD W/RMT IN@MAX (KW)**—Set the Base Load reference value when the remote reference input is at the maximum value for the selected range.
- 11 RMT BSLOAD REF INPUT (KW)** displays the baseload reference based on analog input #2. **NOTE:** this displayed value is the result of the input parameter, it is not limited by the ramp times or switch input logic.
- 12 RMT BSLOAD INC TIME(SEC)**—Set the time for the Base load reference to ramp from the 4 mA setting to the 20 mA setting.
- 13 RMT BSLOAD DEC TIME(SEC)**—Set the time for the Base load reference to ramp from the 20 mA setting to the 4 mA setting.
- 14 REMOTE AUX SCALE(%/VOLT)**—Set the gain of the remote input when used to bias speed from a remote control device. The normal scale is 3.0% speed change per volt input. The Analog Input range is ±2.5 V.
- 15 SYNC INPUT SCALE(%/VOLT)**—Set the gain of the synchronizer input when used to bias speed from a speed and phase matching device. The normal scale is 0.7% speed change per volt input. The Analog Input range is ±2.5 V.
- 16 SYNC INPUT, ANIN #1 (VDC)** displays the voltage input from a synchronizer at terminals 19 and 20.

J** KW INPUT CALIBRATION **

This section calibrates the 2301D internal load sensor to correspond its output to measured kilowatts. This calibration allows the control to calculate the 100% Load Gain voltage, droop %, and load sharing ratio. For proper calibration the generator load should be as close as possible to required generator voltage and unity power factor.

- 01 KW INPUT CALIBRATN ZERO**—Adjust until the KW reading below is zero when the generator output is zero.
- 02 KW INPUT CALIBRATN GAIN** is adjusted for the load sensor output to match the external instrumentation readings.
- 03 GEN OUTPUT (READ KW)** is the output of the engine sensed load and should match external instrumentation
- 04 LOAD SIGNAL OUT (VDC)** converts the generator kW into the load Gain voltage value.

K** ANALOG OUTPUT SETTINGS**

This section sets the parameter to be sent to the analog output driver and the desired scaling of the output.

- 01 ANALOG OUTPUT SEL (1-8)**—Select one of the following parameters for 4–20 mA output at terminals 16,17, and 18.
 - 1. Engine Speed
 - 2. Speed Reference
 - 3. Fuel Demand %
 - 4. Unit Load %
 - 5. System Load %
 - 6. Analog Input #1
 - 7. Analog Input #2
 - 8. Speed Reference Bias
- 02 ANOUT, 4 MA OFFSET** is adjusted for the value of the displayed parameter when the analog output will be 4 mA.
- 03 ANOUT, 20MA SCALE** is adjusted for the value of the displayed parameter when the analog output will be 20.0 mA.
- 04 ANALOG OUT 1 (%)** displays the analog output %, 0% is 4 mA, and 100% is 20 mA.

L**DISCRETE OUTPUT SETTINGS **

This section determines the speed switch pick up and drop out points for the discrete outputs DO1 and DO2 and the load switch pick up and drop out points for DO3 and the timing parameters for the automatic circuit breaker opening output at DO4.

- 01 SPEED SW #1 PICK-UP (RPM)** is the speed at which the discrete output driver at terminal 41 is turned on(energized).
- 02 SPEED SW #1 DROP-OUT (RPM)** is the speed at which the discrete output driver at terminal 41 is turned off.
- 03 SPEED SW #2 PICK-UP (RPM)** is the speed at which the discrete output driver at terminal 42 is Turned on (energized).
- 04 SPEED SW #2 DROP-OUT (RPM)** is the speed at which the discrete output driver at terminal 42 is turned off.
- 05 LOAD SW #1, PICK-UP (KW)** is the load at which the discrete output driver at terminal 43 is turned on (energized).

- 06 **LOAD SW #1, DROP-OUT (KW)** is the load at which the discrete output driver at terminal 43 is turned off.
- 07 **BREAKER OPEN TIME (SEC)** sets the time the automatic circuit breaker command time is will change states (depending on the configuration of CB Open Relay Normally Energized).
- 08 **RAMP @ MIN, CB DELAY (SEC)** is the time delay the load/unload ramp is at minimum value and the generator KW has not reached the unload KW trip level.

M** DISPLAY DIGITAL I/O **

This section has no adjustments to set, it is used only for display of OPEN or CLOSED status of discrete inputs and the ON or OFF status of the discrete outputs.

- 01 **CLOSE RUN/OPEN SHTDWN A** indicates status of discrete input A
- 02 **CLOSE MPU FAIL OVERRD B** indicates status of discrete input B
- 03 **CLOSE RATED/OPEN IDLE C** indicates status of discrete input C
- 04 **CB AUX CONTACT IN D** indicates status of discrete input D
- 05 **RAISE SPEED/LOAD E** indicates status of discrete input E
- 06 **LOWER SPEED/LOAD F** indicates status of discrete input F
- 07 **LOAD GENERATOR G** indicates status of discrete input G
- 08 **SELECT BASE LOAD H** indicates status of discrete input H
- 09 **SPEED SWITCH 1 DO1** indicates status of discrete output DO-1.
- 10 **SPEED SWITCH 2 DO2** indicates status of discrete output DO-2.
- 11 **LOAD SWITCH 1 DO3** indicates status of discrete output DO-3.
- 12 **AUTO CB OPEN DO4** indicates status of discrete output DO-4.
- 13 **INTERNAL CB AUX RELAY** indicates status of discrete output driving the internal load sharing relay.

N** DISPLAY ANALOG I/O **

This section displays the analog inputs to and the outputs from the control.

- 01 **SPEED SENSOR INPUT (RPM)** displays actual engine speed.
- 02 **LOAD SENSOR INPUT (KW)** displays generator load in kilowatts.
- 03 **SYNCINPUT, ANIN #2 (VDC)** displays the voltage input from a synchronizer at terminals 19 and 20.
- 04 **ANIN #2, INPUT TYPE:** This will display one of the following string to indicate the input range selected for input 2:
 - ±2.5 V
 - 4–20 mA
 - 0–20 mA
 - 0–5 V
 - 1–5 V
- 05 **ANIN #2 (UNITS)**—The units of the input type above (volts or mA) are the units of the Analog Input #2 value displayed here.
- 06 **LOAD SHARING LINES (VDC)** will read the voltage present at terminals 10 and 11.
- 07 **LOAD SHARING BIAS SIG (%)** is the error signal to the speed reference from the load sharing and/or droop circuitry.
- 08 **ACTUATOR CURRENT (mA)** is the *calculated* actuator output current in milliamps. This calculation is based on the percent fuel demand and the actuator type/range selected. External wiring may effect the accuracy of the actual current.

- 09 **ANALOG OUT 1 (%)** is the output at terminal 16 and 17, 0% is 4 mA, 100% is 20 mA.
- 10 **LOAD SIGNAL (Vdc)** is the generator kW converted to load gain volts.

O**PID CONTROL PARAMETERS**

This is a display of the input to the PID control. The values entered in the Dynamic tuning section are normalized values and the values displayed here can be used for stability analysis if needed.

- 01 **DYNAMICS 2 ENABLED, TRUE** indicates the system is in the isochronous mode (CB aux is closed) and Dynamics 2 values are input to the PID controller.
- 02 **PID GAIN VALUE** is the proportional value into the PID.
- 03 **PID INTEGRAL GAIN VALUE** is the Integral value into the PID, Reset rate.
- 04 **PID SDR VALUE** is the derivative or lead term into the PID.

P** DISPLAY MENU **

This is a display group for general monitoring of the engine/generator.

- 01 **ENGINE SPEED (RPM)** displays actual engine RPM.
- 02 **CALC GENERATOR FREQ (Hz)** is the engine RPM converted to generator output frequency.
- 03 **SPEED REFERENCE (RPM)** is the speed reference or desired speed.
- 04 **FUEL DEMAND (%)** represents the engine fuel, actuator input.
- 05 **SPEED REF BIAS SUM (RPM)** is a display of the total speed bias into the summing junction.
- 06 **LOAD BIAS (RPM)** is the speed bias for the load sharing and droop section of the control.
- 07 **SYNC BIAS (RPM)** is the speed bias from the speed and phase match device input to the control.
- 08 **BASE LOAD REF (KW)** displays the KW reference value of the baseload mode.
- 09 **GENERATOR OUT (KW)** displays generator load in kilowatts.
- 10 **LOAD SIGNAL OUT (VDC)** indicates the generator kW in units of load Gain voltage. The value will vary from 0.0 to the value entered in H** LOAD SETTINGS **, LOAD GAIN VOLTAGE when the generator load varies from 0 to rated KW.
- 11 **FUEL CONTROL MODE** gives the control loop in control of actuator output.
- 12 **LOAD CONTROL PARAMETER** gives the control mode in control of the engine load.

Q*MANUAL RELAY/ANOUT TEST**

This section allows the operator to test the relay driver outputs and the analog output by artificially forcing its signal. The engine must be shut down at minimum fuel. If the test is enabled, the actuator output will be held to minimum.

- 01 **ENABLE MANUAL DRIVR TEST**—When the engine is at zero speed and minimum actuator output tune this to TRUE. The status below will read 'Test On'
- 02 **TURN ON DO1**—Tune to TRUE to turn the driver output #1 on.
- 03 **TURN ON DO2**—Tune to TRUE to turn the driver output #2 on.
- 04 **TURN ON DO3**—Tune to TRUE to turn the driver output #3 on.

- 05 **TURN ON DO4**—Tune to TRUE to turn the driver output #4 on.
- 06 **TURN ON INT CB AUX RELAY**—Tune to TRUE to energize the internal load sharing relay, observe the green LED next to terminals 9 and 10.
- 07 **ADJUST ANALOG OUTPUT #1**—Adjust 0 to 100 for analog output at 16 and 17 to change from 0 to 20mA.
- 08 **FORCE OUTPUT STATUS** indicates if force test is on or off, also indicates if attempt to enable testing while engine is running.

R** PRESTART SETTINGS **

This display sheet can be used to observe and set values critical to engine operation during initial installation startup and testing.

- 01 **RATED SPEED (RPM)** is the engine rated speed reference.
- 02 **5 SLOPE GAIN IS CONFIGRD** shows if the 5 point gain dynamics is enabled, FALSE indicates that single slope dynamics is enabled.
- 03 **DYNAMICS 2 IS ENABLED** indicates that when the circuit breaker is closed DYNAMICS 2 will be in control.
- 04 **PROP GAIN 1** determines how fast the control responds to an error in engine speed from the speed-reference setting. The Gain is set to provide stable control of the engine at light or unloaded conditions.
- 05 **RESET 1** compensates for the lag time of the engine. It adjusts the time required for the control to return the speed to zero error after a disturbance. Reset is adjusted to prevent slow hunting and to minimize speed overshoot after a load disturbance.
- 06 **ACTUATOR COMPENSATION 1** compensates for the actuator and fuel system time constant. Increasing Compensation increases actuator activity and transient performance.
- 07 **GAIN RATIO 1**, is the ratio of the Gain setting at steady state to the Gain setting during transient conditions. The Gain Ratio operates in conjunction with the Window Width and Gain adjustments by multiplying the Gain set point by the Gain Ratio when the speed error is greater than the Window Width. This makes the control dynamics fast enough to minimize engine-speed overshoot on start-up and to reduce the magnitude of speed error when loads are changing. This allows a lower gain at steady state for better stability and reduced steady-state actuator linkage movement (see Figure 3-1).
- 08 **ACCEL RAMP TIME (SEC)** is the time required for the control to ramp the engine speed from Idle speed to Rated speed. The ramp is started whenever the Idle/Rated contact is closed.
- 09 **DECEL RAMP TIME (SEC)** is the time required for the control to ramp the engine speed from Rated speed to Idle speed. The ramp is started whenever the Idle/Rated contact is opened.
- 10 **LOAD GAIN VOLTAGE** Enter the load gain voltage at 100% load. A value of 6.0 is usually sufficient to allow load sharing with other units using 0–3 Vdc analog load sharing lines. This value must be common with all other controls connected to the common Load Sharing Signal.
- 11 **LOAD DROOP PERCENT** is the percentage of rated speed the speed reference will droop when the generator load is increased to maximum load. Set to desired droop percent.

- 12 START FUEL LIMIT (%FD)** limits the percent fuel demand when the engine is started. The limit is usually set at the fuel level required to start the engine. The limiter is disabled when the engine fuel is controlled by speed (see Figure 3-4). The limiter begins out of the way at 100% with no speed. Upon speed exceeding the Failed speed sense percent, the START FUEL LIMIT immediately limits the fuel to the start fuel limit level. The limiter then ramps at START RAMP RATE (%FD/S) until the speed has reached 95% of reference and the Speed Control PID is in control for 1 second.



Read this entire procedure before starting the prime mover.

Initial Prestart Settings

The prestart settings can be viewed and/or adjusted in the **R** PRESTART SETTINGS **** sheet in Watch Window.

1. RATED SPEED—Set to Generator synchronous speed.
2. For initial startup, configure the control for single slope gain dynamics. Turn off DYNAMICS 2, use only Dynamics 1 adjustments for initial startup.
3. RESET 1—Set at 5.0.
4. GAIN 1—Set at 4.0.
5. ACTUATOR COMPENSATION 1—Set the ACTUATOR COMPENSATION at 2.0 for diesel or fuel injected gasoline prime movers. Set the ACTUATOR COMPENSATION at 6.0 for carbureted gas or gasoline prime movers.
6. Set GAIN RATIO 1 to 1.0 to disable the effect of window width and gain ratio.
7. ACCEL RAMP TIME—Set at 20 sec.
DECEL RAMP TIME—Set at 20 sec.
8. LOW IDLE SPEED—Set at idle speed rpm, (no lower than 20% of rated).
9. LOAD GAIN—Set at 6.0, or the value of other load sharing controls on a common bus.
10. DROOP—Set at desired percentage.
11. START FUEL LIMIT—Set at 100%.
12. Be sure the actuator is connected to terminals 13 and 14.

Start-up Adjustments

1. Complete the Configuration Procedure in Chapter 2, and the initial prestart settings above.

NOTICE

Be sure the Rated Speed and Number of Teeth are set correctly for your application as described earlier in this chapter.

2. Close the Close For Rated contact. Set the control for isochronous operation by closing the droop/CB Auxiliary and the generator Load contact.

IMPORTANT

This is for initial prime mover start-up only. For normal start-up, the Close for Rated contact (open for idle/close for rated) should be open if the prime mover is to start at idle.

3. Apply input power to the control.

4. Preset rated speed.
When using a signal generator to verify the proper configuration setting: set the signal generator for the frequency of the speed sensor at rated speed, and connect it to terminals 25 and 26. (The rated speed frequency in Hz equals the rated prime mover speed in rpm times the number of teeth on the speed sensing gear divided by 60.) Put the Close For Rated contact in the rated (closed) position. Connect a dc analog voltmeter to terminals 13(+) and 14(-) to read actuator voltage. If the actuator voltage is at minimum (minimum will be approximately 0 volts), slowly decrease the input frequency (increase for reverse acting controls) until the voltage just begins to move to maximum. If the actuator voltage is at maximum, slowly increase the input frequency (decrease for reverse-acting controls) until the voltage just begins to move to minimum. Continue to very slowly adjust the input frequency in the appropriate direction, trying to stop the actuator voltage between the minimum and maximum voltages. Because it is not possible to stop the motion, cease adjusting when the voltage changes slowly. The RATED SPEED configuration has been verified. No further adjustment when the engine is running will be necessary.
5. Check the speed sensor.
Minimum voltage required from the speed sensor to operate the electronic control is 1.0 Vrms, measured at cranking speed or the lowest controlling speed. For this test, measure the voltage while cranking, with the speed sensor connected to the control. Before cranking, be sure to prevent the prime mover from starting. The frequency required to clear the Loss of Speed shutdown is entered as a percent of rated speed during configuration. For example, at 5% of 1800 rpm rated speed, the failed speed sensing circuit is cleared at 90 rpm.



Be prepared to make an emergency shutdown when starting the engine, turbine, or other type of prime mover, to protect against runaway or overspeed with possible personal injury, loss of life, or property damage.

6. Start the prime mover.

Adjust For Stable Operation

If prime mover operation is stable, go to the “Speed Setting Adjustment” procedure. If the prime mover is hunting at a rapid rate, slowly decrease the GAIN until performance is stable. If the prime mover is hunting at a slow rate, increase the RESET until the prime mover stabilizes. If increasing the RESET does not stabilize the prime mover, it also may be necessary to either:

- Slowly decrease the GAIN or
- Slowly decrease the GAIN and increase the ACTUATOR COMPENSATION.

Speed Setting Adjustment

With the prime mover operating stably, adjust the RATED SPEED to bring the prime mover to the desired operating speed.

Dynamic Adjustment

The object of the GAIN and RESET adjustment is to obtain the optimum, or desired, stable prime mover speed response. Connect a dc analog voltmeter to terminals 13(+) and 14(-) to monitor the actuator voltage.

Increasing the setting of the GAIN to provides faster transient response (decreases the magnitude of the speed change from a sudden change in load). To achieve optimum response, slowly increase the GAIN until the voltage on the voltmeter becomes slightly unstable, then slowly lower the GAIN as necessary to stabilize the meter reading. Step load the generator, bump the actuator terminal shaft, or use the software "Bump Act Trigger (T then F)" in the dynamics tuning sections, to make sure that the prime mover returns to the proper speed with little overshoot or undershoot of the speed setting. To reduce overshoot, increase the RESET. When the RESET is in the lower part of its adjustment (0 to 3 on the scale), increasing the RESET clockwise may require decreasing the GAIN (turning the GAIN counterclockwise) to maintain stable operation. If the prime mover is slow in returning to the proper speed, decrease the RESET.

Actuator Compensation Adjustment

If the ACTUATOR COMPENSATION is set as described under Initial Prestart Settings, no further adjustment is normally required. If a slow periodic instability remains, slightly increase the ACTUATOR COMPENSATION, and repeat the GAIN and RESET adjustments. Continue to increase the ACTUATOR COMPENSATION and readjust the GAIN and RESET until stability is achieved. If a fast instability or extremely active actuator is evident, slightly decrease the ACTUATOR COMPENSATION. If necessary, the ACTUATOR COMPENSATION may be set to .01. This may be required when engine torsionals cause excessive fuel-linkage movement.

Low Idle Speed Adjustment

1. Open external CLOSE FOR RATED contact. The engine speed should decelerate to Idle.
2. Adjust the LOW IDLE SPEED until the recommended idle speed is reached.

IMPORTANT

Make certain that the prime mover speed is controlled by the LOW IDLE SPEED in a range above the minimum-fuel position (mechanical stop) of the actuator or prime mover fuel rack.

IMPORTANT

Make certain that the LOW IDLE SPEED is not within a critical or restricted speed of the prime mover.

Ramp Time Adjustment

Adjust the ACCEL RAMP TIME to achieve satisfactory prime mover acceleration to rated speed with minimum overshoot. The number entered is the time in seconds to change speed from idle to rated.

Adjust the DECEL RAMP TIME to achieve satisfactory prime mover deceleration to idle speed with minimum undershoot. The number entered is the time in seconds to change speed from rated to idle.

Raise/Lower Time Adjustment

Adjust the RAISE SPEED TIME to achieve satisfactory prime mover acceleration toward the raise speed limit with minimum overshoot. The number entered is the time in seconds to change speed from LOWER SPEED LIMIT to RAISE SPEED LIMIT.

Adjust the LOWER SPEED TIME to achieve satisfactory prime mover deceleration toward the lower limit with minimum undershoot. The number entered is the time in seconds to change speed from RAISE SPEED LIMIT to LOWER SPEED LIMIT.

Start Fuel Limit Adjustment

With the prime mover operating at rated speed and no load, note the Fuel Demand % displayed on the HMI. Set the Start Fuel Level 10% higher than the fuel demand noted above. Shut down the prime mover. Start the prime mover and observe the start time, overshoot of speed setting, and smoke emissions obtained. The Start Fuel Limit may be adjusted as required to optimize the prime mover starting characteristics. When the prime mover start is initiated the fuel is set to the start fuel limit, the fuel level is then increased at the rate set by Start Ramp Rate (%FD/Sec). The fuel-limiting function is turned off automatically when the speed control takes over.

IMPORTANT

For prime movers not requiring start fuel limiting, the START FUEL LIMIT function can be deactivated by setting the Start Fuel Limit to 110%.

Speed Sensor Check

Measure the voltage across terminals 25 and 26 to be sure there is a minimum of 1.0 Vrms at cranking speed, and a maximum of 25 Vrms at rated speed. If the voltage exceeds 25 Vrms, increase the gap of the speed sensor, and be sure that there is still a minimum of 1.0 Vrms at cranking speed.

Current Transformer (CT) Phasing Check

IMPORTANT

This control contains internal current transformers. Due to their low impedance, shorting their inputs is not effective. The current input must be removed from the control and shorted externally.

! WARNING

HIGH VOLTAGE—Never disconnect any wire attached to load sensor terminals 4 through 9 when the prime mover is running unless temporary 0.5 Ω , 20 W resistors are installed as shown in Figure 3-7, and all load is removed. The current transformers can develop dangerously high voltages when open circuited while the prime mover is running.

1. Go to the **K** KW INPUT CALIBRATION **** sheet and observe 03 **Gen Output (read KW)** , and **LOAD SIGNAL OUT** to measure the load sensor output. The displayed values are not yet calibrated to read Kilowatts, but is used here for indication.
2. Start the prime mover. With the generator operating in the isochronous mode and not paralleled, load the generator to as near to full load as possible.
3. Use a clamp-on ammeter and measure the per phase current of the Current transformer output. Check that current in each of the three CTs are equal. In a balanced three phase system the Load Signal Out reading will be approximately:

Load Signal Out = kW Input Calibration Gain X 0.1 X AMPs (rms reading of one phase)

A clamp-on ammeter is recommended to eliminate the need to open CT wiring to insert an ammeter in series with the CT output.

4. If the Load Signal Out Reading is within 10% of the above calculation, the PT/CT phasing is correct. If the phasing is incorrect, proceed to the Phase Correction Procedure. If the phasing appears correct, skip the Phase Correction Procedure and go to the Load Calibration Adjustment procedure.

IMPORTANT

If after completing the **LOAD SENSOR CALIBRATION** and **DROOP** adjustments, the control loading is extremely sensitive to changes in the power factor when operating in parallel, complete the phase correction procedure.

IMPORTANT

The most accurate calibration is made at full load. However, if it is not possible to run the generator set at full load, run it at less than full load, and reduce the voltage reading given in this calibration procedure proportionally. For example: run a 200 kW generator set at 100 kW and divide all voltages given in this calibration procedure by 2. If you reduce the load in this manner, be sure to reduce it by the same amount throughout the calibration procedure.

Phase Correction Procedure

IMPORTANT

This procedure requires a minimum power factor of (.9). If a .9 power factor cannot be obtained, tracing through the wiring is the only means of correcting the current transformer phasing.

The highest positive reading of kW or Load Signal Out will be obtained when the CTs are correctly matched to the load sensor terminals in both phase and polarity. The following procedure will assure the correct connection of the current transformers. It is required only if the phasing check indicates incorrect phasing, or loading stability is extremely sensitive to the power factor.

Make trial connections of the first CT to all three load sensor inputs, polarized both ways (a total of six connections). Record the Load Signal Out reading for each connection. Connect the first CT to the terminals that produce the highest positive reading, and with the polarity that produces the highest positive voltage. The displayed Load Gain reading is limited to about 0.2, therefore a negative reading indicates a phasing or polarity error.

Try the second CT on each of the remaining two CT input terminals, in each polarity, and record the Load Signal Out reading. Connect the second CT to the terminals that produce (and with the polarity that produces) the highest positive reading.

Try the last CT on the remaining input terminals, polarized both ways, and record the voltage. Connect the last CT in the polarity that produces the highest Load Signal Out reading.

The Phase Correction Procedure requires that the prime mover be shut down many times to disconnect the current transformers. For convenience, a temporary method of connecting the current transformers shown in Figure 3-8 is recommended. Connecting a 0.5 Ω , 20 W burden resistor across each current transformer allows the current transformers to be disconnected from the terminal strip with the prime mover running, after removing all load.

WARNING

HIGH VOLTAGE—The current transformers can develop dangerously high voltages. Do not disconnect a current transformer while the prime mover is running unless temporary 0.5 Ω , 20 W resistors are installed as shown in Figure 3-8, and all load is removed.

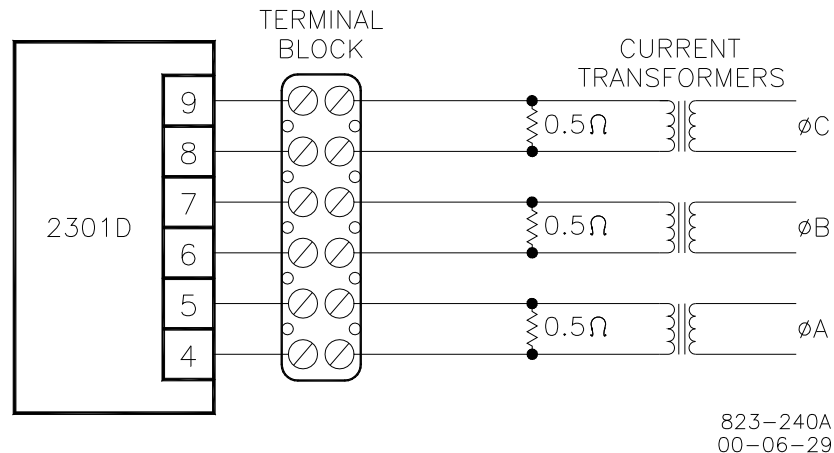

Figure 3-8. Temporary Wiring for Transformer Phase Correction

If the temporary burden resistors described above and shown in Figure 3-8 are not used, the prime mover **MUST** be shut down in addition to removing the load in the following procedure.

Monitor the load sensor output in this procedure by connecting an external computer and entering the Watch Window sheet for **K** KW INPUT CALIBRATION ****. Observe **03 Gen Output (read KW)** Load Sensor calibration and monitoring. Since the kW calibration cannot be completed until the phasing is correct, the value shown is for reference only. The Load Sensor of the 2301D will only read a small negative value.

1. Shut down the prime mover.

WARNING

HIGH VOLTAGE—The current transformers can develop dangerously high voltages. Do not disconnect a current transformer while the prime mover is running unless temporary 0.5 Ω , 20 W resistors are installed as shown in Figure 3-8, and all load is removed.

2. Label each CT wire with the phase and polarity that you think it should be. Even though this identification may prove to be incorrect, this step is necessary so that the individual wires can be identified during the description of the procedure.
3. Disconnect the phase B CT wires from terminals 6 and 7. Connect these two wires together using a small screw and nut, and tape the connection.
4. Disconnect the phase C CT wires from terminals 8 and 9. Connect and tape these two wires together as in Step 3.
5. Connect the two wires from the phase A CT to the phase A input terminals 4 and 5.
6. Start the prime mover, apply full load, and monitor the load sensor output. Start a list and record this value.
7. Unload the system and reverse the phase A CT wires on terminals 4 and 5.*
8. Apply full load, monitor the load sensor, and record this value.
9. Unload the system, remove phase A CT wires from terminals 4 and 5, and connect them to phase B input terminals 6 and 7.*
10. Apply full load, monitor the load sensor, and record this value.
11. Unload the system and reverse the phase A CT wires on terminals 6 and 7.*
12. Apply full load, monitor the load signal, and record this value.
13. Unload the system, remove phase A CT wires from terminals 6 and 7, and connect them to phase C input terminals 8 and 9.*
14. Apply full load, monitor the load sensor, and record this value.
15. Unload the system and reverse the phase A CT wires on terminals 8 and 9.*
16. Apply full load, measure the load signal, and record this reading.
17. Unload the system and compare the six readings taken.*
18. Remove the phase A CT wires from terminal 8 and 9 and connect the phase A wires to the pair of terminals that produced the highest positive load value and in the polarity that produced the highest positive load value.
19. Untape and disconnect the phase B CT wires. Connect the phase B CT wires to one pair of the two remaining pairs of CT input terminals on the load sensor.
20. Apply full load and measure the load signal. Start a new list and record this reading.
21. Unload the system, and reverse the phase B CT wires on the same terminals.*
22. Apply full load, measure the load signal, and record this reading.
23. Unload the system, remove phase B CT wires, and connect them to the other pair of terminals.*
24. Apply full load, measure the load signal, and record this reading.
25. Unload the system and reverse phase B CT wires on the same terminals.*
26. Apply full load and measure the load signal. Record this reading, and compare the four readings on the list.
27. Unload the system. Remove the phase B CT wires and connect them to the pair of CT input terminals that produced the highest positive load signal reading and with the polarity that produced the highest positive load signal reading.*
28. Untape and disconnect the phase C CT wires. Connect these two wires to the remaining pair of CT input terminals.
29. Apply full load, measure the load signal, and record this reading.
30. Unload the system and reverse the phase C CT wires on the same terminals.*
31. Apply full load, measure the load signal, and record this reading.
32. Unload and shut down the system. Compare the two readings.*
33. Connect the phase C CT wires to the same pair of CT input terminals, but in the polarity that produced the highest positive load signal reading.
34. Re-label each wire with the phase designation of the terminal that it is now connected to.
35. Remove the burden resistors and terminal block.

Load Calibration Adjustment

For this procedure, the generator must be running isochronously and not paralleled.

Start the prime mover and apply full load. With the Watch Window at **K** KW INPUT CALIBRATION ****, observe **03 Gen Output (read KW)**. If this reading does not match external instrumentation, adjust calibration gain and offset until Watch Window value matches metering. The values should match at all intermediate points.

NOTICE

***-If values at full load (or a lower reading proportional to a load less than 100%) cannot be obtained, and the phasing has been checked and is correct, the current transformers are probably the wrong size. The current-transformer output must be from 3 to 7 A (5 A nominal) at full load.**

When paralleled in isochronous mode or on an isolated bus, generator speeds must be the same. If speed references are not equal, load sharing will not remain proportional as the load varies. Any difference in loads between the units can be corrected by adjusting the Load Gain. Increasing the LOAD GAIN will cause that generator to carry less load. If stability problems occur when paralleled at a particular load signal reading, reduce the reading by reducing the LOAD GAIN, and reduce the load signal reading setting of all other generators in the system to the same reading. When the load signal readings of all generators in a system are reduced, the load sharing gain will be reduced and this may result in some loss of load sharing sensitivity.

It may be necessary to reduce the load signal reading of each unit in the system to as low as 3 volts in cases of extremely poor system dynamics. If your system requires a load signal reading as low as 3 volts, consult Woodward for suggestions for possible remedies.

Droop Adjustment

Because of the calculation available in the control, the droop percentage entered will result in the correct speed change if the KW sensor is properly calibrated. The droop percent is automatically corrected for load gain voltage values. The speed trim range can be configured to stop the speed reference at 100% load, or if a remote reference source is used its range can be set to give no load to full load limits.

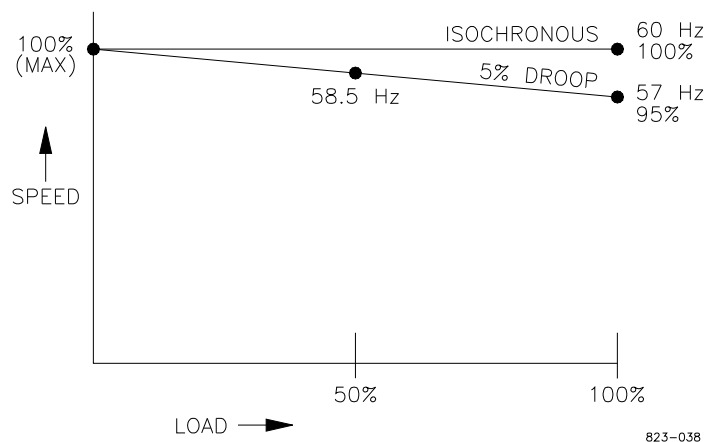

Figure 3-9. Droop Adjustment

Chapter 4.

Description of Operation

Introduction

This chapter provides an overview of the features and operation of the 2301D Load Sharing and Speed Control.

The 2301D Load Sharing and Speed Control uses a 32 bit microprocessor for all control functions. All control adjustments are made with an external computer that communicates with the control via a serial port. The external computer can be disconnected from the control during normal operation, to provide security against tampering.

The speed and load sharing section of these 2301D models monitors and controls two functions:

Speed: The speed control section keeps the prime mover at the correct speed.

Load control: The load control section manages the prime mover load based on the load control mode:

- During parallel operation of two or more generators, the load sharing section senses the load carried by its generator and causes the loads of all generators in the system to be shared proportionally.
- During parallel operation of two or more generator or a generator paralleled against an infinite bus the control may be operated in Baseload mode.
- During parallel operation of two or more generator or a generator paralleled against an infinite bus the control may be operated in Droop mode

Speed Control

The Speed Control system as shown in Figure 4-1 consists of:

- A device (1) to sense the speed of the prime mover
- A frequency sensor to software converter (2)
- A speed reference [software](3) to which the prime mover speed can be compared
- A speed summer/amplifier [software](4) with an output [software to hardware] proportional to the amount of fuel or steam required to maintain the desired speed at any given load
- An actuator (5) to position the fuel or steam mechanism of the prime mover

A speed-sensing device, such as a magnetic pickup, senses the speed of the prime mover, and converts it to an ac signal with a frequency proportional to prime mover speed. The frequency-to-software receives the ac signal from the speed sensor and changes it to a digital number representing prime mover rpm.

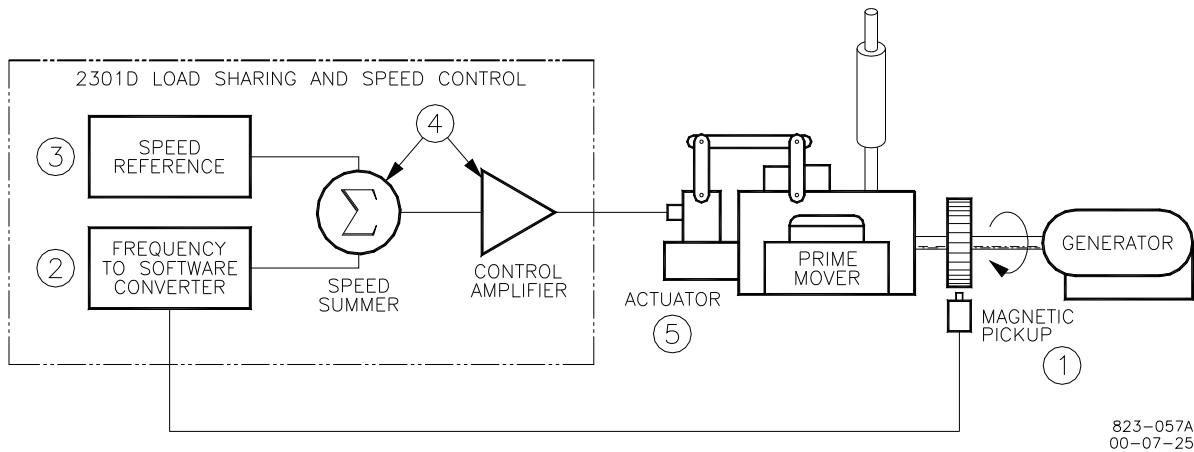

Figure 4-1. Speed Control System

The digital control compares the numeric output of the speed sensor to the numeric number of the speed reference at the summing junction. If the speed is lower or higher than the reference, a response calculated by the PID (Proportional-Integral-Derivative control) is sent to the actuator driver calling for an increase or decrease in actuator current.

The actuator responds to the signal from the actuator driver by repositioning the fuel or steam rack, changing the speed of the prime mover until the speed signal and the reference are equal.

A failed speed signal circuit monitors the speed signal input. When no signal is detected, it calls for minimum fuel. The minimum fuel signal is sufficient to cause the actuator to go to the minimum position if not restricted. However, due to linkage adjustment or other restrictions in the external system, minimum actuator position may not permit prime mover shutdown.

For controls with actuator current of 20 to 160 mA, minimum fuel is defined as:

- Actuator current less than 10 mA for forward-acting controls
- Actuator current greater than 180 mA for reverse-acting controls

A contact to override the failed speed signal circuit can be connected in series with terminal 32. Temporarily closing the contact overrides the failed speed signal circuit as may be required for start-up.

Control Dynamics

RESET, GAIN, and ACTUATOR COMPENSATION adjust the control to accommodate various types of prime mover systems. RESET adjustment affects prime mover reaction time when recovering after a sudden load change. The magnitude of the speed change resulting from a sudden change in load is controlled by adjusting the GAIN. ACTUATOR COMPENSATION compensates for the time the actuator and prime mover fuel system takes to react to signals from the control.

Constant dynamics refers to dynamics parameters that will remain constant as entered and do not vary with engine speed. Dynamics may be configured to vary with load by using the 5-Gain mapped dynamics. Constant dynamics are useful for fuel systems and processes that tend to be equally stable throughout the prime movers speed and load range. Variable dynamics vary gain by the ratio of actual engine speed to rated speed. The 5 point Gain mapped dynamics is a two-dimensional curve with five breakpoints that vary gain as a function of fuel demand or kW. The 5 point Gain mapped dynamics compensate for non-linear fuel systems and are useful for engines or processes whose dynamics change in a non-linear manner with load.

The control can automatically switch between two gain settings, based on engine speed error, to provide improved transient load performance. Speed error is the difference between the speed reference and engine speed. The control automatically increases gain by an adjustable ratio when a speed error exceeding an adjustable window occurs (See Figure 3-1). During steady-state constant-load operation, the control uses the base gain setting. This base gain is adjusted by the user to a value which prevents the control from responding to minor speed fluctuations inherent with reciprocating engines. This feature essentially eliminates harmful jiggle of the actuator and fuel system linkage. When the speed error exceeds an adjustable window width (e.g., during a load transient), the control automatically increases gain by an adjustable ratio. This increased gain produces a faster fuel response and quickly restores engine speed at the speed reference. The base gain is restored once the control senses a return to steady-state operation. This feature is available for all gain choices. Furthermore, this feature is active when paralleled to a utility grid. Although actual engine speed does not change, the speed reference is changed when corrective bias signals are applied by load sharing or droop during load transients. Large corrective bias signals will produce a large speed error to automatically increase gain.

The control also provides a second complete set of dynamic adjustments which are selected when the CB Aux discrete input is activated. Two sets of dynamics are useful where engine operating conditions change, such as in electrical power generation systems where the unit operation changes when in parallel with a bus.

Minimum Fuel Function

The Minimum Fuel Function brings the fuel demand to zero. This occurs when the Close to Run discrete input goes FALSE. It also occurs if the speed sensor input has failed when the Close MPU Fail Overrd B input is FALSE. The Close to Run command is the preferred means for a normal shutdown of the engine.



The Close to Run discrete input is not intended for use as the sole means of shutdown in any emergency stop sequence. To prevent possible serious injury and engine damage from an overspeeding engine, do NOT use the Close to Run discrete input as the sole means of shutdown in any emergency stop sequence.

Maximum Fuel Function

The Maximum Fuel Function is a software-adjustable maximum fuel limit on the fuel demand. It is used to set a maximum position of the actuator. This is generally used to prevent engine overloading or other situations where the maximum fuel delivered to the engine should be limited. The function can be disabled by adjusting the Max Fuel Limit to 100%. The maximum fuel limiter is disabled in systems configured for reverse acting actuator.

Start Limit Function

The Start Limit Function provides a limit to the fuel demand which prevents overfuel conditions during starting of the engine (Figure 4-2). During start-up, when engine speed exceeds the MPU fail speed, the Start Limit Function is momentarily triggered to immediately limit the fuel demand to a software-adjustable start fuel limit. The start ramp begins increasing the fuel demand at a software-adjustable rate shortly after the start fuel limit is triggered. The rate can be set at zero to eliminate the ramp function. When engine speed reaches 95% of the speed reference, and the PID is in control of the fuel demand for 1 second, the Start Limit Function will immediately increase to a maximum value of 100%. When engine speed decreases below 5% of rated speed from a shutdown, the Start Fuel Limit Function is disabled and re-armed for trigger during the next start. The start fuel limit function also works on reverse-acting systems. The function can be disabled by adjusting the Start Fuel Limit to a value of 100.

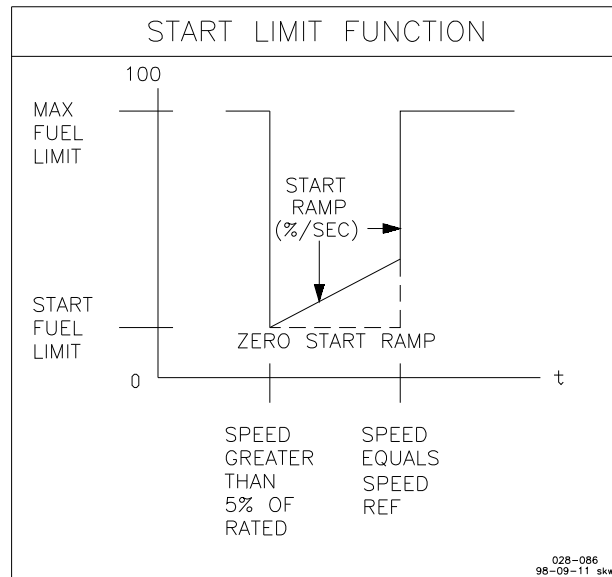

Figure 4-2. Start Limit Function

Speed/Load Reference and Ramps

The 2301D control provides local control with discrete inputs for raising and lowering speed/load. For remote speed/load setting, the control provides a remote reference analog input. Input functions are enabled as follows:

- Local Speed/Load Reference Raise/Lower discrete inputs control the speed ramp inputs when the CB Aux input is open.
- Remote Speed/Load Reference setting is enabled when the Raise Speed/Load and Lower Speed/Load contacts are both closed, the Rated contact is closed, and Remote Reference input is selected as Speed Reference setting or as Baseload reference setting.

Speed Reference and Ramp Functions

This section describes the operation of the speed reference and ramp functions and their relation to each other. Read this section carefully to be sure your sequencing provides the proper operating modes.

The control provides start, idle, lower limit, raise limit, and rated set points, accel and decel times, and raise and lower rates, for local operation. Accel time determines the time required for the engine to ramp from start to idle speed and from idle to rated speed. Decel time determines the time required for the engine to ramp from rated speed to idle speed. Raise and lower rates determine how fast speed is increased or decreased by raise and lower discrete input commands.

The Start Speed can be enabled for applications which need this function (e.g., spark gas recip engines). The start speed set point provides a speed reference above cranking speed but below the speed achieved with the start fuel limit setting (light-off speed). This function is configurable. The default has this function disabled. When configured TRUE, the Start reference is selected, by control power-up, engine not running, or engine cranking. The Start reference is the speed reference until the engine starts. After the engine speed exceeds the start speed set point the speed will accelerate by a controlled ramp to the reference selected by the Idle/Rated contact input. This may not be the desired mode of operation, so be sure to understand the implications of operating the control in this manner.

The idle speed set point is provided for engine warm-up or cool-down cycles. Idle speed may be set equal to or less than the rated speed set point. Idle is independent of the lower limit set point and may be set at a lower speed. The idle speed set point is selected when the Rated contact is open, if the start reference is removed either by configuration or engine speed above start speed. Closing the Rated contact ramps the speed set point from idle to rated, if the start reference is removed.

Closing either the raise or lower contacts while ramping from idle to rated results in immediate cancellation of the idle to rated ramp, and the ramp will stop at that point. After acceleration to rated speed is completed, the raise and lower commands increase and decrease engine speed based on the raise and lower rate settings. The raise and lower commands will not increase the speed reference above the raise limit or below the lower limit. The raise and lower commands can be used as speed trim inputs for manual synchronization. Or if the system uses droop operation for paralleling, the raise and lower inputs will be load setting inputs.

If remote speed setting operation is configured and enabled after the engine reaches rated speed, the control will ramp speed to the reference value set by the Remote Reference input at the Remote Reference increase or decrease time settings. The Remote Reference range is selectable and can be configured for one of four operating ranges: from 4 to 20 mA, 0 to 20 mA, 1 to 5 V, or 0 to 5 V. The minimum input value (4mA, 0mA, 0 V, or 1 V) Remote Reference set point may be set to a lower or higher speed than the high input (20 mA or 5 V) set point, providing for either direct or reverse-acting remote speed setting.

If the Remote Speed Reference input is configured and enabled when the Idle/Rated contact is closed or during the idle to rated ramp, the speed reference will ramp to the Remote Reference input value at the remote reference increase or decrease rate settings. This may not be the desired mode of operation, so be sure to understand the implications of operating the control in this manner.

If a difference is detected between the present speed reference and the remote reference rpm value, the present speed reference is ramped up or down at the increase or decrease rate until the present speed reference matches the remote speed reference rpm value. The remote reference will not increase/decrease the speed reference above the maximum input value or below the minimum input value. (see Figure 4-3).

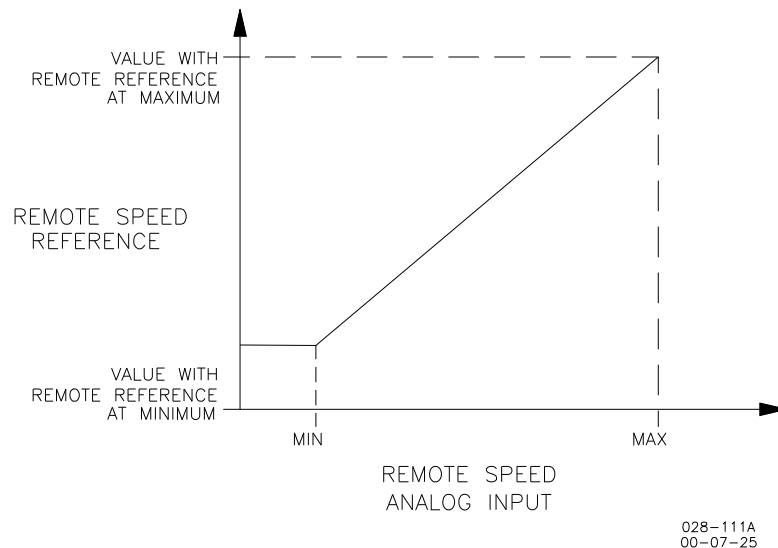

Figure 4-3. Remote Speed Reference

Speed Bias and Synchronizer Summing

There are three functions that can change the speed reference from the set point that was determined in the above paragraphs:

- Synchronizer bias input
- Load bias input
- Auxiliary bias input

The synchronizer input is used to match the prime movers speed and generator phase with bus that it is being paralleled to. Analog input #1 at terminals 19,20,and 21 is used as the synchronizer input. The sensitivity of the synchronizer can be adjusted.

The load bias is the signal from the load control function that will bias the speed reference to increase or decrease the speed or generator load. When the generator is paralleled to other units, a change in speed reference bias will result in a change in generator load, in an isolated generator the load bias will give a change in speed (droop).

The third speed bias can occur when the control is configured for Analog input #2 to come from an auxiliary load control device. This external control will affect the speed reference as required depending on its load control mode.

Load Reference and Ramp Functions

This section describes the operation of the load reference and ramp functions and their relation to each other. Droop operating mode has no ramp functions and is not included here. Isochronous load sharing descriptions apply to two or more units paralleled on a common isolated bus or by accessory device with the utility. Baseload descriptions apply to a unit paralleled with the utility or with one or more units on an isolated bus. Read this section carefully to be sure your sequencing provides the proper operating modes.

The control provides an unload trip level set point, baseload set point, rated load set point, loading rate, unloading rate, and fast loading rate. Loading rate determines the kW per second increase when the load input is closed. Unloading rate determines the kW per second decrease when the load input is opened (unload). The 2nd loading rate (usually a fast kW/sec rate) are enabled by the Enable fast load rate prompt to TRUE in the LOAD SETTING menu, and setting a system load percent level which will activate the fast load rate. This mode could be useful in an emergency start situation where the generator set could be loaded at a fast rate.

When the system load is high, the oncoming generator will load at a fast rate to assume its share of the load quicker. In the isochronous mode (CB Aux input closed), closing the load contact ramps the load set point from no-load to the load sharing setting. Opening the load contact (unload) ramps the load to the unload trip level setting. At the unload trip level a Circuit Breaker open signal is issued. Closing the baseload contact ramps the load set point from no-load or the load sharing setting to the baseload reference. Opening the baseload contact ramps the load to the load sharing setting. When in baseload operation, the baseload reference determines the load on the generator without regard to other units connected to the same load. When the generator is carrying less load than the base load reference, the load bias is positive and the closed loop path increases the fuel to the engine. When the generator is carrying more load than the base load reference, the load bias is negative and the closed loop path will decrease the fuel to the engine. As the fuel to the engine is changed, the load and/or speed will change until the engine speed exactly matches the biased speed reference. At this steady state base load condition, the load bias is virtually zero and the biased speed reference, rated speed reference, and engine speed are virtually equal.

Opening the baseload input contact ramps the generator load from base load back into isochronous load sharing. However, opening the load input contact (unload) instead, ramps the generator load from the base load setting to the unload trip level where a breaker trip signal is issued after a tunable time delay.

IMPORTANT

In isolated bus applications, a brief speed transient may occur when the load sharing relay closes following transfer from baseload back into isochronous load sharing.

It is possible for the control to be in base load control while supplying power to a load which is isolated from the infinite bus. The capability of the engine generator must be considered when operating this way. As an example consider two generators, one capable of providing 1200 kW and one capable of providing 600 kW. If the combined load demand to these generators is 750 kW while the 1200 kW generator is in steady state isochronous load sharing and the 600 kW generator is in steady state base load with a set point of 250 kW, the 1200 kW generator will again be carrying 500 kW and the 600 kW generator will again be carrying 250 kW. However, now as the total load demand increases only the 1200 kW generator will respond to the increase. At a combined load demand of 1450 kW, the 1200 kW generator will carry 1200 kW while the 600 kW generator in base load will still be carrying 250 kW. If the load demand exceeds 1450 kW, the steady state frequency of the bus will decrease and the load supplied by each individual generator will increase.

Soft Loading

The load command discrete input contact controls soft loading. If the load command discrete input is closed when the breaker (CB AUX) input contact closes, the generator will soft load to the reference level of the mode selected (load sharing or base load). If the load command discrete input is open (unload) when the breaker (CB AUX) closes, the generator will immediately load to the Unload Trip Level set in the KW Setting menu. When the load command discrete input is closed, the generator will soft load to the reference level of the mode selected (load sharing or base load). The ramp rate is adjustable.

Soft Unloading and Open Generator Breaker Relay Output

If the load command discrete input contact is opened (unload) while the breaker (CB AUX) input contact is closed, the generator will soft unload from the present load level to the unload trip level. Once the generator load has reached the unload trip level or the reference has been there for 5 seconds (tunable), the Open Gen Breaker relay output will open for 1 second (tunable). The load command discrete input must be maintained OPEN to complete the unload sequence.

IMPORTANT

The Load Command discrete input must be maintained logic to operate the Soft Loading/Unloading sequence. The input must be OPEN to complete the Unload sequence and disconnect the generator. The input must be CLOSED to complete the Load sequence and operate the generator in Isochronous Load Sharing or Base Load operating mode.

CB AUX	Base Load	Load Gen	Lower Spd/Ld	Raise Spd/Ld	Operation of Load Control
F	X	X	X	X	Droop
F	X	X	T	F	Droop lower load
F	X	X	F	T	Droop raise load
F	X	X	T	T	Droop remote load ref
T	F	T	X	X	Isochronous load sharing
T	T	T	X	X	Base load
T	T	T	F	F	Base load ref will ramp to internal base load reference
T	T	T	F	T	Base load ref will ramp toward rated load
T	T	T	T	F	Base load ref will ramp toward the unload trip level
T	T	T	T	T	Base load ref will ramp to value of remote load set point
T	X	F	X	X	Base load control at the unload trip level
T	X	T-F	X	X	Load will ramp to unload trip level and open gen breaker

Legend: F=False, T=True, X=Don't Care

Table 4-1. Description of Discrete Inputs While in Load Control

Droop Function

Load control operations are not functional while in droop. The speed reference must be changed to increase or decrease the generator load while in droop. The base load and the load discrete inputs have no effect while operating in the droop mode. The CB Aux contact switches between load control and droop operation.

The droop function supplies a feedback path to bias the speed reference. The function of droop is to decrease the speed reference as the load increases. This is done by negatively biasing the output of the speed reference with the droop function. The CB Aux discrete input contact is used to switch the droop function on and off. The droop function can be permanently enabled by leaving the CB Aux contact discrete input false. A complete discussion of droop operation is included in the Power System Management Concepts section.

Power System Management Concepts

This section provides a summary review of droop, isochronous, droop/isochronous, isochronous load sharing, and base load operating concepts. These concepts provide an understanding for power management.

Paralleling

There are two basic methods used for paralleling: droop, where speed decreases with load increase, and isochronous, where speed remains constant with load increase. The paralleling system shown in Figure 4-4 consists of a load matching circuit (1), and kW sensor circuitry(2).

027-023B
00-07-25

Figure 4-4. Paralleling System

An auxiliary contact on the generator breaker connected to terminal 34 is used to select isochronous load control operation. A contact in series with the auxiliary contact may be used to select either the droop or isochronous mode of operation. When the input to the CB Aux contact is open, the control is in droop. When the CB Aux contact is closed, the control is in isochronous load control.

With only one unit on line, the generator picks up the available load and remains at isochronous speed. If other units are on line and the load command discrete input is open, the load will immediately load to the Unload Trip Level setting. When the Load contact connected to terminal 37 is closed the load matching circuit corrects the fuel output to proportion load.

The Load sensor computes the load carried by each phase of the generator. The current load on each phase is multiplied by the cosine of the phase difference between the current and the voltage, and the three phases are added to determine the total load.

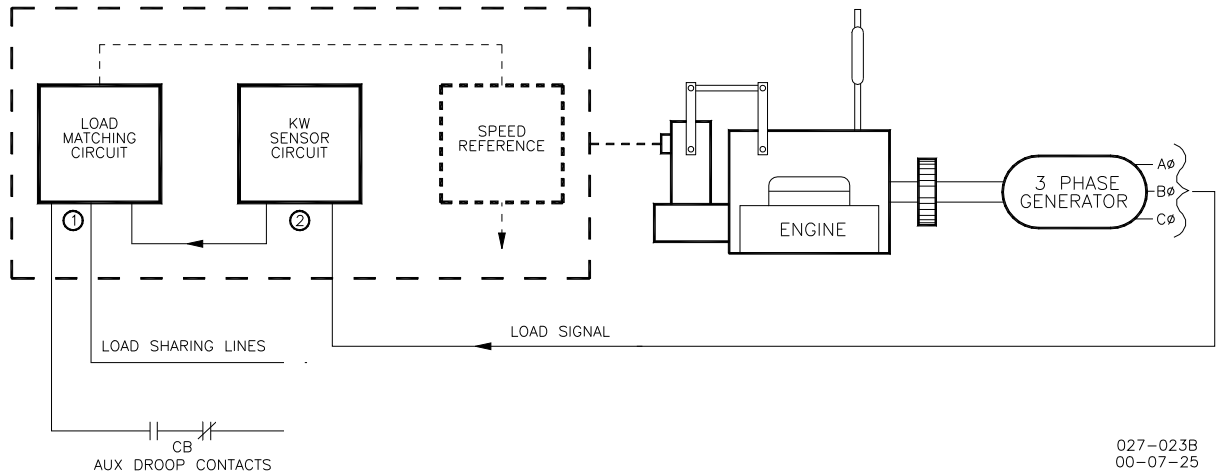
The output of the load amplifier is adjusted by the load gain set point. By setting the load gain voltage on each unit to the same level at full load, proportional load sharing is achieved. Regardless of differences in generator set capacities in the system, each generator set is loaded to the same percentage of its capacity. A final adjustment of the individual load gain adjustment will compensate for minor differences in the generator sets.

When the Baseload contact connected to terminal 38 is closed proportional load sharing is terminated and the load is ramped either up or down to the baseload reference setting.

Droop mode allows operation of a generator on an infinite bus or in parallel with other engine generator units using hydromechanical governors. In droop, speed changes as the load on the generator changes. An increase in load results in a decrease in speed. The amount of speed change or droop is expressed in percent (of rated speed) and is set by the load droop set point.

Droop Mode

Droop is a decrease in speed or frequency, proportional to load. That is, as the load increases, the speed or frequency decreases, as illustrated in Figure 4-5. This reduction in speed is accomplished with negative feedback. The feedback increases as the system is loaded.

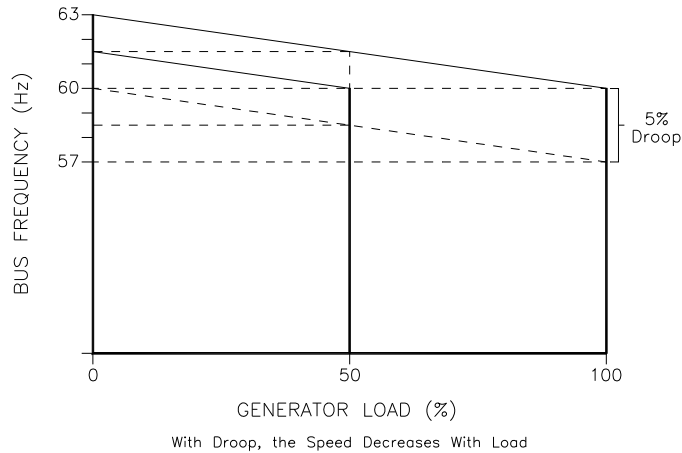

027-024
96-02-01

Figure 4-5. Droop Mode

Droop is expressed as the percentage reduction in speed that occurs when the generator is fully loaded. With a given droop setting, a generator set will always produce the same power output at a particular speed or frequency. Droop is sometimes called the percent speed regulation. If all generator sets in a droop system have the same droop setting, they will each share load proportionally. The amount of load will depend on their speed settings. If the system load changes, the system frequency will also change. A change in speed setting will then be required to offset the change in feedback and return the system to its original speed or frequency. In order for each generator set in the system to maintain the same proportion of the shared load, each generator will require the same change in speed setting.

Isochronous Mode

Isochronous means repeating at a single rate or having a fixed frequency or period. A generator set operating in the isochronous mode will operate at the same set frequency regardless of the load it is supplying, up to the full load capability of the generator set (see Figure 4-6). This mode can be used on one generator set running by itself in an isolated system.

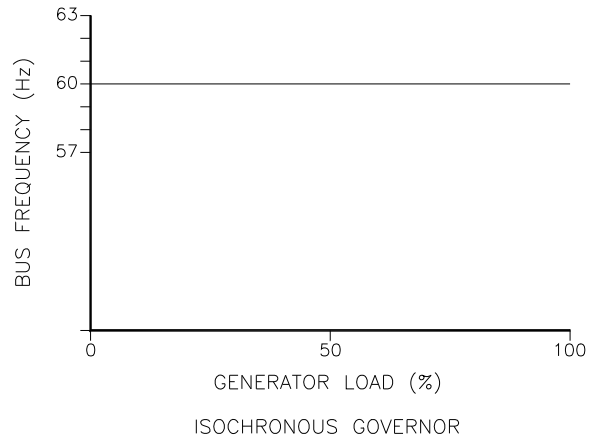
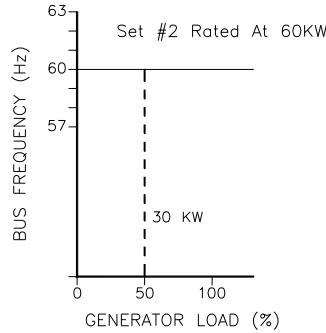
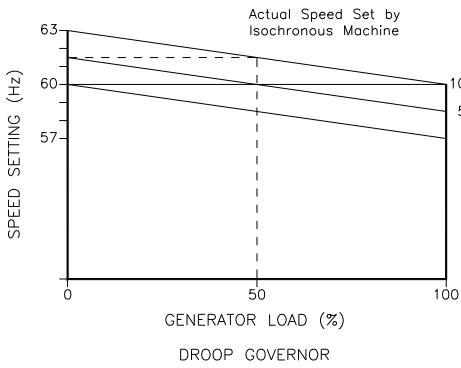
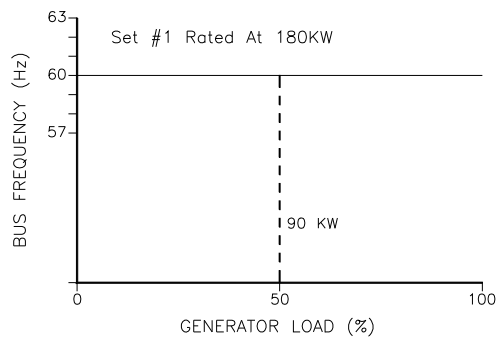
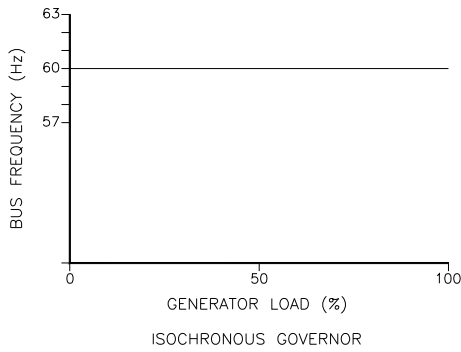

Figure 4-6. Isochronous Mode

The isochronous mode can also be used on a generator set connected in parallel with other generator sets. Unless the governors are load sharing and speed controls, however, no more than one of the generator sets operating in parallel can be in the isochronous mode. If two generator sets operating in the isochronous mode without load sharing controls are tied together to the same load, one of the units will try to carry the entire load and the other will shed all of its load. In order to share load with other units, some additional means must be used to keep each generator set from either trying to take all the load or from motoring.

Droop/Isochronous Load Sharing on an Isolated Bus

Droop/isochronous load sharing combines the first two modes. All generator sets in the system except one are operated in the droop mode. The one unit not in droop is operated in the isochronous mode. It is known as the swing machine. In this mode, the droop machines will run at the frequency of the isochronous unit. The droop and speed settings of each droop unit are adjusted so that each generates a fixed amount of power (see Figure 4-7). The output power of the swing machine will change to follow changes in the load demand. Maximum load for this type of system is limited to the combined output of the swing machine and the total set power of the droop machines. The minimum system load cannot be allowed to decrease below the output set for the droop machines. If it does, the system frequency will change, and the swing machine can be motored. The machine with the highest output capacity should be operated as the swing machine, so that the system will accept the largest load changes within its capacity.



Isochronous Maintains Frequency and Load Swings
Droop Units Maintain a Set Load

027-026
96-02-01

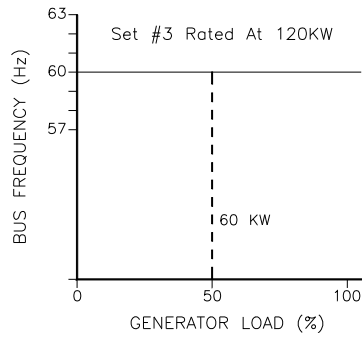

When Properly Set Up, Each Engine-Generator Set
Supplies Its Proportional Share of the Load

027-027
96-02-01

Figure 4-7. Droop/Isochronous Load Sharing

Figure 4-8. Isochronous Load Sharing

Isochronous Load Sharing on an Isolated Bus

Isochronous load sharing operates all generator sets in a system in the isochronous mode. Load sharing is accomplished by adding a load sensor to each electric isochronous governor. The load sensors are interconnected by the load sharing lines. Any imbalance in load between units will cause a change to the regulating circuit in each governor. While each unit continues to run at isochronous speed, these changes force each machine to supply a proportional share of power to meet the total load demand on the system (see Figure 4-8).

Base Load on an Isolated Bus

Base Load is a method of setting a base or fixed load on a machine operating in parallel with an isolated bus. This is accomplished by using an isochronous load control and providing a reference at which to control the load. The governor will force the generator output to increase or decrease until the output of the load sensor is equal to the reference setting. At this point, the system is in balance. This method can only be used where other generator sets are producing enough power to meet the changes in load demand. This operating mode is ideal for either soft loading additional units into an isochronous system, or for derating or unloading a machine.

Base Load

Base Load for a system paralleled to an infinite bus or utility is the same as base load in an isolated system. The advantage of base loading over droop is that when separating from a utility, there is no frequency change. Simply removing the bias signal on breaking from the utility returns the system to isochronous.

Chapter 5.

Troubleshooting

Introduction

The following troubleshooting guide is an aid in isolating trouble to the control box, actuator, plant wiring, or elsewhere. Troubleshooting beyond this level is recommended ONLY when a complete facility for control testing is available.

IMPORTANT

The control can be damaged with the wrong voltage. When replacing a control, check the power supply, battery, etc., for the correct voltage.

Troubleshooting Procedure

This chapter is a general guide for isolating system problems. The guide assumes that the system wiring, soldering connections, switch and relay contacts, and input and output connections are correct and in good working order. Make the checks in the order indicated. Various system checks assume that the prior checks have been properly done.

WARNING

Be prepared to make an emergency shutdown when starting the engine, turbine, or other type of prime mover, to protect against runaway or overspeed with possible personal injury, loss of life, or property damage.

Control Start-up

When the control is powered on, the CPU begins execution of a section of the software program known as the boot code. This code performs hardware diagnostics and checks that a valid application program has been installed. During this period all control outputs will remain disabled. The boot code takes approximately 30 seconds to execute. During this period the red status LED should be on. When execution of the boot code has completed, control will be transferred to the application program. When the application program begins, the control outputs will be enabled and system control will begin. At that point the red status LED will be turned off and should remain off as long as the control is running.

If the control fails its self-test diagnostics during boot, fails its on-line self-tests while running the application program, or fails in any other way that it can detect, then the CPU will blink the red status LED to indicate the failure.

NOTICE

To prevent damage to the prime mover, the prime mover must be shut down for all system checks.

Control Test and Calibration

General

Do the following checks on the 2301D control. Then verify the functioning of set points and adjustments.

1. Connect a computer to the communication port. Start Watch Window HMI software in accordance with the instructions in Chapter 3. Verify that correct voltage and polarity are applied to the control.
2. Verify the controller ID on the 2301D Standard PC Interface by clicking “Control” then “Properties”. The Application ID message (part number with the revision level [new, A, etc]) should appear.
3. Select the 1st Dynamics Menu. Verify that all set points are as recorded during installation. Repeat for the other menus. If any differences are found, change the set point(s) to the correct value. Click the “SAVE VALUES” icon on the Tool bar. Remove power from the control for at least 10 seconds. Verify correct values were retained during power down. Failure indicates the control has failed and should be replaced.

Discrete Inputs

Do the following test to verify the function of the discrete inputs. Do NOT do this test with the engine running.

1. Repeat this step for all discrete inputs. Close the appropriate input. The status in DISPLAY DIGITAL I/O should switch from OPEN to CLOSED. If the value does not change when the contact is closed, the control has failed and should be replaced.

Discrete Outputs

To Verify operation of the Discrete Outputs, go to the RELAY AND ANOUT TESTS sheet. With the engine shut down, enable the manual relay driver test. Open another inspector sheet, select DISPLAY DIGITAL I/O, and monitor the discrete outputs DO1 – DO4. From the relay test procedure, each discrete output may be activated and its operation verified. If the output is activated, the same voltage as applied at terminal 39 and 40 should be measured between terminal 39 and the appropriate output terminal (41–44). Testing of the internal CB Aux relay may be done by observing the green LED near terminal 9 and 10, or hearing an audible ‘click’. The manual relay test must be disabled (status “test off”) or the control will hold the actuator current to minimum.

Symptom	Cause	Solution
<p>Prime mover will not start. Actuator not moving to start fuel position.</p> <p>IMPORTANT</p> <p>If the actuator moves to start position, a problem with the prime mover fuel supply is indicated.</p>	Supply voltage polarity reversed (dc only), or no supply voltage.	<p>On power up the CPU status LED should come on for 30 seconds.</p> <p>Check for proper voltage from terminals 45(+) to 46(-). Reverse leads if polarity is incorrect.</p>
	Actuator not responding to input signal from control.	<p>IMPORTANT</p> <p>The hydraulic actuator must have oil pressure and gear rotation to operate (respond).</p> <p>If there is a voltage output at control terminals 13(+) and 14(-), but the actuator does not move, the wiring to the actuator should be checked for opens or shorts. With the EG3P actuator, remember that terminals C and D of the mating plug should be jumpered.</p> <p>Make resistance checks at the actuator. Coil resistance on Woodward actuators is approximately 35 Ω. (Read with leads at terminals 13 and 14 disconnected.)</p>
	Start fuel limit set too low.	Check Fuel Demand % in the Display Menu. If it is not going to Start Fuel value when cranking, check to see Engine Speed is reading cranking speed. If Fuel Demand is reading 0, increase the Start Fuel Limit.
	Actuator or linkage.	Check actuator and linkage for proper installation and operation. Problems may be oil supply, direction of rotation, insufficient drainage, linkage, worn actuator components, or improper adjustment.
	No actuator voltage at terminals 13 and 14.	<p>Check for shorted or grounded actuator leads by removing wires to terminals 13 and 14. Stop prime mover. Close the switch on terminal 32 (Failed Speed Sensor Override). Check for 18 to 22 V at terminals 13 and 14 for forward acting controls, and 0 to 1 volt for reverse acting controls.</p> <p>Check that Display Menu is reading engine speed during cranking. If no speed reading, check the MPU.</p> <p>Check for at least 1 Vrms at terminals 28 and 29, and at least 5% of the minimum rated speed frequency range.</p>
	Speed setting too low on initial start.	Control may be configured for the wrong speed range. Check that the number of teeth and the rated speed have been entered correctly. Speed setting may be lower than cranking speed. Control should be set for rated speed.
	LOW IDLE SPEED setting may be set too low.	Check that the LOW IDLE SPEED setting is entered correctly.
	Minimum Fuel contact open. See "MINIMUM FUEL CONTACT" in Chapter 2.	Check terminal 31. Minimum fuel contact must be closed for normal operation. Check for 20 to 40 Vdc from terminal 31(+) to 30(-).

Symptom	Cause	Solution
Prime mover will not start. Actuator not moving to start fuel position (continued).	Speed sensor signal not clearing failed speed signal circuit.	<p>Check wiring for proper connection. Check shields for proper installation. Check the Display Menu for Engine Speed reading.</p> <p>Speed sensor not spaced properly—check for at least 1.0V ac at terminals 25 and 26 during cranking. If less than 1.0 Vac, magnetic pickup may be spaced too far from gear. Make sure there are no metal chips on end of pickup.</p> <p>If no voltage is present, magnetic pickup may be open-circuited or shorted. Make resistance check with the leads disconnected from control. Should be about 100 to 300 Ω.</p> <p>Failed speed signal circuit may be disabled by connecting terminal 28 to terminal 32.</p> <p> WARNING</p> <p>Be prepared to make an emergency shutdown when starting the engine, turbine, or other type of prime mover, to protect against runaway or overspeed with possible personal injury, loss of life, or property damage.</p>
	Faulty 2301D control.	Replace.
Prime mover overspeeds only on starts.	Ramp adjustment.	Increase RAMP TIME. This decreases acceleration rate (from low idle to rated).
	RATED SPEED setting too high.	Check that RATED SPEED is entered as described in Chapter 3. Verify the Fuel Demand % drops to minimum (0%) when engine speed is greater than speed reference.
	Dynamics adjustment.	Dynamics may be adjusted for sluggish operation, causing overspeed on start. Adjust GAIN for fastest stable response. RESET may be adjusted too low. Increase RESET setting.
	Determine if engine is malfunctioning.	Verify that fuel rack is not binding and linkage is properly adjusted. Determine if the fuel rack is quickly following the actuator input voltage. Check operation of overspeed protection device(s).

Symptom	Cause	Solution
Prime mover overspeeds or causes excessive smoke only on starts.	Start Fuel Limit is inactive.	Power up 2301D before cranking engine.
	2301D control.	If the control does not cut back the actuator voltage [terminals 20(+) and 21(-)] when engine speed is greater than speed reference, the control may be programmed for the wrong speed range. If the voltage is cut back, look for a problem in the linkage or actuator.
Prime mover overspeeds after operating at rated speed for some time.	Prime mover.	Check for proper operation of prime mover fuel system. If actuator moves toward minimum fuel during overspeed, problem is in fuel system.
	Magnetic pickup and 2301D control.	Check the magnetic pickup output voltage at speeds above idle—at least 1.0 Vrms. If magnetic pickup should fail and the override failed speed signal circuit is disabled, the 2301D control will call for maximum fuel.
	2301D control.	Control the prime mover manually at rated speed. If the Engine Speed reading in the Display Menu does not match external indicators, the control is not configured properly. When the engine speed value is greater than the speed reference value, the output voltage should be zero. If speed range is correct for the application, replace the control.
Low speed is not regulated by LOW IDLE SPEED.	<p>IMPORTANT</p> <p>On carbureted prime movers, the minimum fuel stop rpm setting will vary with prime mover temperature. An improper cold setting may give interference with the LOW IDLE SPEED setting when the prime mover is hot.</p>	<p>The LOW IDLE SPEED setting may be below the minimum fuel position of the actuator or prime mover fuel stop. In this case, the output voltage to the actuator will be zero.</p> <p>The engine will be maintained at the minimum fuel position by the actuator or the prime mover minimum fuel stop. The conditions above indicate that the prime mover minimum fuel position should be decreased by linkage adjustment (diesel engine) or low idle set screw (gas engine), or the LOW IDLE SPEED setting should be raised. If this action does not correct the problem, the 2301D control may be faulty.</p>

Symptom	Cause	Solution
Prime mover does not decelerate when Close for Rated contact is open.	Faulty Close for Rated contact.	Check Close for Rated contact. Remove wire from terminal 32. Prime mover should decelerate.
	LOW IDLE SPEED set the same as rated	Check the Speed Settings Menu.
	Generator Aux contact is closed.	A faulty Close for Rated contact may remain in the accelerate position with the contact open. In general, adjustment of LOW IDLE SPEED will vary the speed of the prime mover with the Close for Rated contact in the decelerate (open) position. Adjustment of LOW IDLE SPEED should not affect prime mover speed when the Close for Rated contact is closed.
Prime mover will not stabilize at rated no load speed. The instability may occur at no load or it may vary with load Control may be erratic.	2301D control.	Adjust GAIN, RESET, and ACTUATOR COMPENSATION as described in "Adjust for Stable Operation" and "Dynamic Adjustment" in Chapter 3.
	Speed reference controls.	Check display menu. The speed reference value should be constant. If speed reference is erratic, check remote input (if used), intermittent raise/lower contact inputs. The speed bias sum at no load should be constant.
	Improper linkage adjustment.	Make sure that actuator moves approximately 2/3 of its travel from no load to full load. Be sure linkage is linear on turbine, diesel, and fuel-injected prime movers. Be sure linkage is non-linear on carbureted prime movers. Refer to actuator manual for proper installation.

Symptom	Cause	Solution
<p>Prime mover will not stabilize at rated no load speed. The instability may occur at no load or it may vary with load Control may be erratic (continued).</p>	<p>Necessary external wires not properly shielded.</p> <p>Electrical noise, caused by wiring carrying an ac voltage, stray magnetic fields from transformers, etc., can be picked up by improperly shielded wire. Noise will cause instability if picked up by lines associated with the amplifier summing point such as external speed trim, paralleling lines, droop contact, magnetic pickup lines, and synchronizer input.</p>	<p>The following tests will isolate noise and interference.</p> <div data-bbox="824 262 1138 338" style="background-color: #003366; color: white; padding: 5px; text-align: center; font-weight: bold; font-size: 1.2em;">NOTICE</div> <p>Do not perform these tests in other than single-unit operating configuration.</p> <p>Jumper terminal 28 to terminal 33 and remove wires to the Close for Rated contact.</p> <p>Remove wires to terminals 10, 11, 34–38, 19, and 20. Jumper terminals 28 and 34.</p> <p>Remove the wires to the minimum fuel contact at terminal 31.</p> <p>Verify that the switchgear frame, governor chassis, and prime mover have a common ground connection. Temporarily remove the battery charger cables from the control battery system.</p> <p>If the prime mover operation is significantly improved by these modifications, replace the wiring one at a time to locate the source of the trouble.</p> <p>External wiring may require additional shielding or rerouting from high-current lines or components.</p> <p>If the problem cannot be resolved by these checks, it will be necessary to remove the 2301D control from the switchgear. Temporarily mount it next to the prime mover and connect only a battery, magnetic pickup, and actuator to the control (use a separate battery placed next to the prime mover). After starting the prime mover, place a small jumper wire across terminals 28 to 33 and terminals 29 to 30 to cause the prime mover to accelerate to rated speed. If necessary, apply load to check stability.</p> <p>[continued]</p>

Symptom	Cause	Solution
Prime mover will not stabilize at rated no load speed. The instability may occur at no load or it may vary with load Control may be erratic (continued).	Necessary external wires not properly shielded (continued).	If stability occurs when the control is mounted next to the prime mover, return the control to the switchgear. Run new magnetic pickup, actuator, and battery power lines. Shield all wires to the control. Route all wires through conduit or an outer shield. Tie the outer shield to system ground at end opposite of the control.
	Prime mover may not be receiving fuel as called for by the actuator voltage.	Check actuator linkage to fuel controlling mechanism for any lost motion, binding, or excessive loading. Verify a steady fuel pressure of proper value. Check actuator per appropriate actuator manual.
	Prime mover not operating properly.	Prime mover may be causing speed variations. Control engine manually to determine if instability is in prime mover or governor control. Verify proper adjustment of fuel control linkage.
	Input voltage low.	Check supply voltage. It should be at least 18 Vdc.
Prime mover does not share load with other units.	Prime mover not receiving fuel as called for by the governor.	If voltage to actuator is maximum (minimum for reverse acting), visually determine if actuator shaft is at maximum position. If it is not, an actuator problem is indicated, or the linkage or fuel system is restricted.
	Unequal speed settings.	Be sure that speed settings of all units at no load are identical.
	Unequal load gain voltages.	With the prime mover operating in single unit configuration, LOAD GAIN must be set at 6.0 Vdc. See LOAD GAIN ADJUSTMENT in Chapter 3.
	Circuit breaker auxiliary contact or droop contact is open.	Check auxiliary circuit breaker and droop contacts. Check for 20 to 40 Vdc from terminal 30 to 34 on low voltage controls.
	Improper load sensing phasing.	Perform phasing procedure in Chapter 3.
	Circulating currents between generators.	Refer to appropriate voltage regulator manual.
Prime mover does not maintain constant speed (isochronous).	Actuator.	If actuator has a ballhead backup, verify that its hydraulic governor section, speed setting, and speed droop adjustments are properly set (see the applicable governor manual).
	Prime mover.	If the droop occurs near the full-load point only, it is possible the prime mover is not producing the horsepower called for by the fuel control, or is being overloaded. Either is indicated if the fuel control is at maximum position.

Chapter 6. Service Options

Product Service Options

If you are experiencing problems with the installation, or unsatisfactory performance of a Woodward product, the following options are available:

- Consult the troubleshooting guide in the manual.
- Contact the manufacturer or packager of your system.
- Contact the Woodward Full Service Distributor serving your area.
- Contact Woodward technical assistance (see “How to Contact Woodward” later in this chapter) and discuss your problem. In many cases, your problem can be resolved over the phone. If not, you can select which course of action to pursue based on the available services listed in this chapter.

OEM and Packager Support: Many Woodward controls and control devices are installed into the equipment system and programmed by an Original Equipment Manufacturer (OEM) or Equipment Packager at their factory. In some cases, the programming is password-protected by the OEM or packager, and they are the best source for product service and support. Warranty service for Woodward products shipped with an equipment system should also be handled through the OEM or Packager. Please review your equipment system documentation for details.

Woodward Business Partner Support: Woodward works with and supports a global network of independent business partners whose mission is to serve the users of Woodward controls, as described here:

- A **Full Service Distributor** has the primary responsibility for sales, service, system integration solutions, technical desk support, and aftermarket marketing of standard Woodward products within a specific geographic area and market segment.
- An **Authorized Independent Service Facility (AISF)** provides authorized service that includes repairs, repair parts, and warranty service on Woodward's behalf. Service (not new unit sales) is an AISF's primary mission.
- A **Recognized Engine Retrofitter (RER)** is an independent company that does retrofits and upgrades on reciprocating gas engines and dual-fuel conversions, and can provide the full line of Woodward systems and components for the retrofits and overhauls, emission compliance upgrades, long term service contracts, emergency repairs, etc.
- A **Recognized Turbine Retrofitter (RTR)** is an independent company that does both steam and gas turbine control retrofits and upgrades globally, and can provide the full line of Woodward systems and components for the retrofits and overhauls, long term service contracts, emergency repairs, etc.

A current list of Woodward Business Partners is available at www.woodward.com/support/directory.cfm.

Woodward Factory Servicing Options

The following factory options for servicing Woodward products are available through your local Full-Service Distributor or the OEM or Packager of the equipment system, based on the standard Woodward Product and Service Warranty (5-01-1205) that is in effect at the time the product is originally shipped from Woodward or a service is performed:

- Replacement/Exchange (24-hour service)
- Flat Rate Repair
- Flat Rate Remanufacture

Replacement/Exchange: Replacement/Exchange is a premium program designed for the user who is in need of immediate service. It allows you to request and receive a like-new replacement unit in minimum time (usually within 24 hours of the request), providing a suitable unit is available at the time of the request, thereby minimizing costly downtime. This is a flat-rate program and includes the full standard Woodward product warranty (Woodward Product and Service Warranty 5-01-1205).

This option allows you to call your Full-Service Distributor in the event of an unexpected outage, or in advance of a scheduled outage, to request a replacement control unit. If the unit is available at the time of the call, it can usually be shipped out within 24 hours. You replace your field control unit with the like-new replacement and return the field unit to the Full-Service Distributor.

Charges for the Replacement/Exchange service are based on a flat rate plus shipping expenses. You are invoiced the flat rate replacement/exchange charge plus a core charge at the time the replacement unit is shipped. If the core (field unit) is returned within 60 days, a credit for the core charge will be issued.

Flat Rate Repair: Flat Rate Repair is available for the majority of standard products in the field. This program offers you repair service for your products with the advantage of knowing in advance what the cost will be. All repair work carries the standard Woodward service warranty (Woodward Product and Service Warranty 5-01-1205) on replaced parts and labor.

Flat Rate Remanufacture: Flat Rate Remanufacture is very similar to the Flat Rate Repair option with the exception that the unit will be returned to you in “like-new” condition and carry with it the full standard Woodward product warranty (Woodward Product and Service Warranty 5-01-1205). This option is applicable to mechanical products only.

Returning Equipment for Repair

If a control (or any part of an electronic control) is to be returned for repair, please contact your Full-Service Distributor in advance to obtain Return Authorization and shipping instructions.

When shipping the item(s), attach a tag with the following information:

- return authorization number;
- name and location where the control is installed;
- name and phone number of contact person;
- complete Woodward part number(s) and serial number(s);
- description of the problem;
- instructions describing the desired type of repair.

Packing a Control

Use the following materials when returning a complete control:

- protective caps on any connectors;
- antistatic protective bags on all electronic modules;
- packing materials that will not damage the surface of the unit;
- at least 100 mm (4 inches) of tightly packed, industry-approved packing material;
- a packing carton with double walls;
- a strong tape around the outside of the carton for increased strength.

NOTICE

To prevent damage to electronic components caused by improper handling, read and observe the precautions in Woodward manual 82715, *Guide for Handling and Protection of Electronic Controls, Printed Circuit Boards, and Modules*.

Replacement Parts

When ordering replacement parts for controls, include the following information:

- the part number(s) (XXXX-XXXX) that is on the enclosure nameplate;
- the unit serial number, which is also on the nameplate.

Engineering Services

Woodward offers various Engineering Services for our products. For these services, you can contact us by telephone, by email, or through the Woodward website.

- Technical Support
- Product Training
- Field Service

Technical Support is available from your equipment system supplier, your local Full-Service Distributor, or from many of Woodward's worldwide locations, depending upon the product and application. This service can assist you with technical questions or problem solving during the normal business hours of the Woodward location you contact. Emergency assistance is also available during non-business hours by phoning Woodward and stating the urgency of your problem.

Product Training is available as standard classes at many of our worldwide locations. We also offer customized classes, which can be tailored to your needs and can be held at one of our locations or at your site. This training, conducted by experienced personnel, will assure that you will be able to maintain system reliability and availability.

Field Service engineering on-site support is available, depending on the product and location, from many of our worldwide locations or from one of our Full-Service Distributors. The field engineers are experienced both on Woodward products as well as on much of the non-Woodward equipment with which our products interface.

For information on these services, please contact us via telephone, email us, or use our website: www.woodward.com/support.

How to Contact Woodward

For assistance, call one of the following Woodward facilities to obtain the address and phone number of the facility nearest your location where you will be able to get information and service.

Electrical Power Systems

Facility	Phone Number
Brazil	+55 (19) 3708 4800
China	+86 (512) 6762 6727
Germany:	
Kempen	+49 (0) 21 52 14 51
Stuttgart	+49 (711) 78954-0
India	+91 (129) 4097100
Japan	+81 (43) 213-2191
Korea	+82 (51) 636-7080
Poland	+48 12 295 13 00
United States	+1 (970) 482-5811

Engine Systems

Facility	Phone Number
Brazil	+55 (19) 3708 4800
China	+86 (512) 6762 6727
Germany:	
Stuttgart	+49 (711) 78954-0
India	+91 (129) 4097100
Japan	+81 (43) 213-2191
Korea	+82 (51) 636-7080
The Netherlands	+31 (23) 5661111
United States	+1 (970) 482-5811

Turbine Systems

Facility	Phone Number
Brazil	+55 (19) 3708 4800
China	+86 (512) 6762 6727
India	+91 (129) 4097100
Japan	+81 (43) 213-2191
Korea	+82 (51) 636-7080
The Netherlands	+31 (23) 5661111
Poland	+48 12 295 13 00
United States	+1 (970) 482-5811

You can also contact the Woodward Customer Service Department or consult our worldwide directory (www.woodward.com/support/directory.cfm) for the name of your nearest Woodward distributor or service facility.

Technical Assistance

If you need to telephone for technical assistance, you will need to provide the following information. Please write it down here before phoning:

Your Name _____

Site Location _____

Phone Number _____

Fax Number _____

Engine/Turbine Model Number _____

Manufacturer _____

Number of Cylinders (if applicable) _____

Type of Fuel (gas, gaseous, steam, etc) _____

Rating _____

Application _____

Control/Governor #1

Woodward Part Number & Rev. Letter _____

Control Description or Governor Type _____

Serial Number _____

Control/Governor #2

Woodward Part Number & Rev. Letter _____

Control Description or Governor Type _____

Serial Number _____

Control/Governor #3

Woodward Part Number & Rev. Letter _____

Control Description or Governor Type _____

Serial Number _____

If you have an electronic or programmable control, please have the adjustment setting positions or the menu settings written down and with you at the time of the call.

Appendix. Service/Configure Chart

CONFIGURE: INPUT AND OUTPUT OPTIONS

01 REVERSE ACTING ACTUATOR	*FALSE
02 ACTUATOR OUT TYPE(1,2,3)	*1 (1, 3)
03 RMT INPUT#2 IS SPEED REF	*FALSE
04 RMT INPUT#2 BASELOAD REF	*FALSE
05 SEL REF IN TYPE/RNG(1-4)	*1 (1, 4)
06 RMT INPUT#2 AUX(DSLC) IN	*FALSE
07 CB OPEN RELAY NORM ENGZD	*FALSE

CONFIGURE: ENGINE & SPEED CONTROL

01 ENTER RATED SPEED (RPM)	*900 (300, 3601)
02 ENTER NUM OF GEAR TEETH	*30 (16, 500)
03 ENTER FAILED SPD SENSE %	*5.0 (2.0, 50.0)
04 USE START SPEED	*FALSE
05 ENABLE 5 SLOPE GAIN MAP	*FALSE
06 5 SLOPE GAIN LOAD IS KW%	*FALSE
07 ENTER RATED/MAX LOAD(KW)	*120 (10, 6000)

SERVICE: A DYNAMICS #1 ****

01 PROP GAIN 1	*4.0 (0.01, 10.0)
02 RESET 1	*5.0 (0.01, 10.0)
03 ACTUATOR COMPENSATION 1	*2.0 (0.11, 10.0)
04 WINDOW WIDTH 1 (RPM)	*60.0 (1.0, 200.0)
05 GAIN RATIO 1	*1.0 (1.0, 10.0)
06 SPEED FILTER FREQ 1 (HZ)	*20.0 (4.0, 20.0)
07 BUMP ACT TRIG (T THEN F)	*FALSE

SERVICE: B DYNAMICS #2 ****

01 ENABLE DYNAMICS 2 w/CB	*FALSE
02 DELAY DYN 2 ENABLE (SEC)	*0.0 (0.0, 20.0)
03 DELAY DYN 1 ENABLE (SEC)	*0.0 (0.0, 20.0)
04 PROP GAIN 2	*4.0 (0.01, 10.0)
05 RESET 2	*5.0 (0.01, 10.0)
06 ACTUATOR COMPENSATION 2	*2.0 (0.11, 10.0)
07 WINDOW WIDTH 2 (RPM)	*60.0 (1.0, 200.0)
08 GAIN RATIO 2	*1.0 (1.0, 10.0)
09 SPEED FILTER FREQ 2 (HZ)	*20.0 (4.0, 20.0)
10 BUMP ACT TRIG (T THEN F)	*FALSE

SERVICE: CDYNAMICS #1, 5 PT GAIN****

01 BREAKPOINT 1A (%LD)	*99.6 (0.00, 100.0)
02 GAIN @BREAKPOINT 1A	*4.0 (0.01, 10.0)
03 BREAKPOINT 1B (%LD)	*99.7 (0.00, 100.0)
04 GAIN @BREAKPOINT 1B	*4.0 (0.01, 10.0)
05 BREAKPOINT 1C (%LD)	*99.8 (0.00, 100.0)
06 GAIN @BREAKPOINT 1C	*4.0 (0.01, 10.0)
07 BREAKPOINT 1D (%LD)	*99.9 (0.00, 100.0)
08 GAIN @BREAKPOINT 1D	*4.0 (0.01, 10.0)
09 BREAKPOINT 1E (%LD)	*100.0 (0.00, 100.0)
10 GAIN @BREAKPOINT 1E	*4.0 (0.01, 10.0)
11 RESET 1	*5.0 (0.01, 10.0)
12 ACTUATOR COMPENSATION	*2.0 (0.11, 10.0)
13 WINDOW WIDTH 1 (RPM)	*60.0 (1.0, 200.0)
14 GAIN RATIO 1	*1.0 (1.0, 10.0)
15 SPEED FILTER FREQ 1 (HZ)	*20.0 (4.0, 20.0)
16 BUMP ACT TRIG (T THEN F)	*FALSE

SERVICE: DDYNAMICS #2, 5 PT GAIN****

01 ENABLE DYNAMICS 2 w/CB	*FALSE
02 DELAY DYN 2 ENABLE (SEC)	*0.0 (0.0, 20.0)
03 DELAY DYN 1 ENABLE (SEC)	*0.0 (0.0, 20.0)
04 BREAKPOINT 2A (%LD)	*99.6 (0.00, 100.0)
05 GAIN @BREAKPOINT 2A	*4.0 (0.01, 10.0)
06 BREAKPOINT 2B (%LD)	*99.7 (0.00, 100.0)
07 GAIN @BREAKPOINT 2B	*4.0 (0.01, 10.0)
08 BREAKPOINT 2C (%LD)	*99.8 (0.00, 100.0)
09 GAIN @BREAKPOINT 2C	*4.0 (0.01, 10.0)
10 BREAKPOINT 2D (%LD)	*99.9 (0.00, 100.0)
11 GAIN BREAKPOINT 2D	*4.0 (0.01, 10.0)
12 BREAKPOINT 2E (%LD)	*100.0 (0.00, 100.0)
13 GAIN BREAKPOINT 2E	*4.0 (0.01, 10.0)
14 RESET 2	*5.0 (0.01, 10.0)
15 ACTUATOR COMPENSATION 2	*2.0 (0.11, 10.0)
16 WINDOW WIDTH 2 (RPM)	*60.0 (1.0, 200.0)
17 GAIN RATIO 2	*1.0 (1.0, 10.0)
18 SPEED FILTER FREQ 2 (HZ)	*20.0 (4.0, 20.0)
19 BUMP ACT TRIG (T THEN F)	*FALSE

SERVICE: E ACTUATOR BUMP SETUP ****

01 ACT BUMP ENABLE	*FALSE
02 ACT BUMP LEVEL (%FD)	*1.0 (0.0, 25.0)
03 ACT BUMP DURATION (SEC)	*0.11 (0.08, 2.0)
04 BUMP ACT TRIG (T THEN F)	*FALSE

SERVICE: FFUEL LIMITERS SETTINGS****

01 START FUEL LIMIT (%FD)	*100.0 (15.0, 110.0)
02 START RAMP RATE (%FD/S)	*10.0 (1.0, 180.0)
03 MAX FUEL LIMIT (%FD)	*100.0 (50.0, 110.0)

SERVICE: G SPEED SETTINGS ****

01 RATED SPEED (RPM)	*900.0 (300.0, 4000.0)
02 START SPEED (RPM)	*400.0 (1.0, 2100.0)
03 RAISE SPEED LIMIT (RPM)	*1000.0 (0.0, 4000.0)
04 LOWER SPEED LIMIT (RPM)	*800.0 (0.0, 4000.0)
05 IDLE SPEED (RPM)	*600.0 (0.0, 4000.0)
06 ACCEL RAMP TIME (SEC)	*20.0 (1.0, 300.0)
07 DECEL RAMP TIME (SEC)	*20.0 (1.0, 300.0)
08 SPEED TRIM INC TIME(SEC)	*30.0 (1.0, 300.0)
09 SPEED TRIM DEC TIME(SEC)	*30.0 (1.0, 300.0)

SERVICE: H LOAD SETTINGS ****

01 ENTER RATED LOAD (KW)	*120 (10, 6000)
02 LOAD DROOP PERCENT	*5.0 (0.00, 12.0)
03 LOAD GAIN VOLTAGE	*6.0 (0.1, 9.0)
04 BASE LOAD MINIMUM (KW)	*20.0 (10.0, 6000.0)
05 BASE LOAD REFERENCE (KW)	*50.0 (0.0, 6000.0)
06 BASE LOAD MAXIMUM (KW)	*110.0 (10.0, 6000.0)
07 BASELOAD RAISE TIME(SEC)	*60.0 (1.0, 600.0)
08 BASELOAD LOWER TIME(SEC)	*60.0 (1.0, 600.0)
09 UNLOAD TRIP LEVEL (KW)	*5.0 (0.0, 6000.0)
10 LOADING RATE (KW/SEC)	*20.0 (1.0, 600.0)
11 UNLOADING RATE (KW/SEC)	*20.0 (1.0, 600.0)
12 ENABLE FAST LOAD RATE	*FALSE
13 FAST RAMP ENABLE LOAD(%)	*80.0 (1.0, 110.0)
14 FAST RAMP RATE (KW/SEC)	*60.0 (1.0, 600.0)

SERVICE: IANALOG INPUTS SETTINGS****

01 AI 2 CONFIGURED FOR:	
02 ANIN #2, INPUT TYPE:	
03 ANIN #2 (UNITS)	
04 SPEED w/ RMT IN@MIN(RPM)	*800.0 (0.0, 4000.0)
05 SPEED w/ RMT IN@MAX(RPM)	*1000.0 (0.0, 4000.0)
06 RMT SPEED REF INPUT(RPM)	
07 RMT SPDREF INC TIME(SEC)	*30.0 (1.0, 300.0)
08 RMT SPDREF DEC TIME(SEC)	*30.0 (1.0, 300.0)
09 BSLOAD w/RMT IN@MIN (KW)	*20.0 (0.0, 6000.0)
10 BSLOAD w/RMT IN@MAX (KW)	*90.0 (10.0, 6000.0)
11 RMT BSLOAD REF INPUT(KW)	
12 RMT BSLOAD INC TIME(SEC)	*60.0 (1.0, 600.0)
13 RMT BSLOAD DEC TIME(SEC)	*60.0 (1.0, 600.0)
14 REMOTE AUX SCALE(%/VOLT)	*3.0 (0.1, 5.0)
15 SYNC INPUT SCALE(%/VOLT)	*0.7 (0.1, 5.0)
16 SYNC INPUT, ANIN #1(VDC)	

SERVICE: J KW INPUT CALIBRATION ****

01 KW INPUT CALIBRATN ZERO	*0.0 (-20.0, 20.0)
02 KW INPUT CALIBRATN GAIN	*10.0 (5.0, 40.0)
03 GEN OUTPUT (READ KW)	
04 LOAD SIGNAL OUT (VDC)	

SERVICE: KANALOG OUTPUT SETTINGS****

01 ANALOG OUTPUT SEL (1-8)	*1 (1, 8)
02 ANOUT, 4 MA OFFSET	*0.0 (-200.0, 200.0)
03 ANOUT, 20MA SCALE	*100.0 (-200.0, 200.0)
04 ANALOG OUT 1 (%)	

SERVICE: LDISCRETE OUT SETTINGS****

01 SPEED SW #1,PICK-UP(RPM)	*500.0 (-10.0, 4300.0)
02 SPEED SW#1,DROP-OUT(RPM)	*400.0 (-10.0, 4300.0)
03 SPEED SW #2,PICK-UP(RPM)	*2100.0 (-10.0, 4300.0)
04 SPEED SW#2,DROP-OUT(RPM)	*400.0 (-10.0, 4300.0)
05 LOAD SW #1, PICK-UP (KW)	*50.0 (-10.0, 6000.0)
06 LOAD SW #1,DROP-OUT (KW)	*60.0 (-10.0, 6000.0)
07 BREAKER OPEN TIME (SEC)	*1.0 (0.8, 60.0)
08 RAMP @ MIN,CB DELAY(SEC)	*5.0 (1.0, 10.0)

SERVICE: M DISPLAY DIGITAL I/O ****

01 CLOSE RUN/OPEN SHTDWN A	
02 CLOSE MPU FAIL OVERRD B	
03 CLOSE RATED/OPEN IDLE C	
04 CB AUX CONTACT IN D	
05 RAISE SPEED/LOAD E	
06 LOWER SPEED/LOAD F	
07 LOAD GENERATOR G	
08 SELECT BASE LOAD H	
09 SPEED SWITCH 1 DO1	
10 SPEED SWITCH 2 DO2	
11 LOAD SWITCH 1 DO3	
12 AUTO CB OPEN DO4	
13 INTERNAL CB AUX RELAY	

SERVICE: N DISPLAY ANALOG I/O ****

01 SPEED SENSOR INPUT (RPM)
 02 LOAD SENSOR INPUT (KW)
 03 SYNC INPUT, ANIN #1(VDC)
 04 ANIN #2, INPUT TYPE:
 05 ANIN #2 (UNITS)
 06 LOAD SHARING LINES (VDC)
 07 LOAD SHARING BIAS SIG(%)
 08 ACTUATOR CURRENT (MA)
 09 ANALOG OUT 1 (%)
 10 LOAD SIGNAL OUT (VDC)

SERVICE: ODISPLAY PID PARAMETERS****

01 DYNAMICS 2 ENABLED
 02 PID GAIN VALUE
 03 PID INTEGRAL GAIN VALUE
 04 PID SDR VALUE

SERVICE: P DISPLAY MENU ****

01 ENGINE SPEED (RPM)
 02 CALC GENERATOR FREQ (Hz)
 03 SPEED REFERENCE (RPM)
 04 FUEL DEMAND (%)
 05 SPEED REF BIAS SUM (RPM)
 06 LOAD BIAS (RPM)
 07 SYNC BIAS (RPM)
 08 BASE LOAD REF (KW)
 09 GENERATOR OUT (KW)
 10 LOAD SIGNAL OUT (VDC)
 11 FUEL CONTROL MODE
 12 LOAD CONTROL PARAMETER

SERVICE: QRELAY AND ANOUT TESTS****

01 ENABLE MANUAL DRIVR TEST *FALSE
 02 TURN ON DO1 *FALSE
 03 TURN ON DO2 *FALSE
 04 TURN ON DO3 *FALSE
 05 TURN ON DO4 *FALSE
 06 TURN ON CB AUX RELAY *FALSE
 07 ADJUST ANALOG OUTPUT #1 *0.0 (0.0, 100.0)
 08 FORCE OUTPUT STATUS

SERVICE: R PRESTART SETTINGS ****

01 RATED SPEED (RPM) *900.0 (300.0, 4000.0)
 02 5 SLOPE GAIN IS CONFIGRD
 03 DYNAMICS 2 IS ENABLED *FALSE
 04 PROP GAIN 1 *4.0 (0.01, 10.0)
 05 RESET 1 *5.0 (0.01, 10.0)
 06 ACTUATOR COMPENSATION 1 *2.0 (0.11, 10.0)
 07 GAIN RATIO 1 *1.0 (1.0, 10.0)
 08 ACCEL RAMP TIME (SEC) *20.0 (1.0, 300.0)
 09 DECEL RAMP TIME (SEC) *20.0 (1.0, 300.0)
 10 LOAD GAIN VOLTAGE *6.0 (0.1, 9.0)
 11 LOAD DROOP PERCENT *5.0 (0.01, 12.0)
 12 START FUEL LIMIT (%FD) *100.0 (15.0, 110.0)

2301D Control Specifications

Woodward Part Numbers:	
8273-101	2301D Load Sharing and Speed Control, 24Vdc input, Ordinary Locations
8273-135	2301D Load Sharing and Speed Control, 24Vdc input, Hazardous Locations
8923-932	Watch Window Installation
Power Supply Rating	18–40 Vdc (SELV)
Power Consumption	less than or equal 20 W nominal
<u>Input Supply Voltage</u>	<u>Input Supply Current</u>
18 V	589 mA
24 V (nominal)	431 mA
32 V	319.6 mA
Inrush Current	7 A for 0.1 ms (low-voltage model)
Inrush Current	22 A for 15 ms (high-voltage model)
Steady State Speed Band	±0.25% of rated speed
Magnetic Pickup	100–25 000 Hz (300–3600 rpm)
Discrete Inputs (8)	3 mA at 24 Vdc, impedance approximately 5.2 kΩ
Remote Reference Input	0–20 mA, 4–20 mA, 0–5 Vdc, 1–5 Vdc, or ±2.5 Vdc externally powered
SPM-A Input	±2.5 Vdc, externally powered
Analog Output #1	0–20 mA, 4–20 or 0–200 mA to actuator, software configurable
Analog Output #2	0–20 or 4–20 mA to tachometer, internally powered
Discrete Outputs (4)	configured to provide two speed switches & two load switches, power by external +12 Vdc or +24 Vdc source, max output current 200 mA
Discrete Output Ratings	Low-side drivers with overvoltage protection, 200 mA maximum
Communication Port (J2)	RS-232, RS-422, 9-pin connector, 1200 to 38 400 baud, full duplex
Ambient Operating Temperature	–40 to +70 °C (–40 to +158 °F)
Storage Temperature	–40 to +105 °C (–40 to +221 °F)
Humidity	Lloyd's Register of Shipping, Test Specification No. 1, 1996, Humidity Test 1, 95% at +20 to +55 °C (+68 to +131 °F) condensing
Mechanical Vibration	Lloyd's Register of Shipping, Test Specification No. 1, Vibration Test 2 (5–25 Hz, ±1.6 mm, 25–100 Hz, ±4.0 g)
Mechanical Shock	US MIL-STD 810C, Method 516.2, Procedure I (basic design test), Procedure II (transit drop test, packaged), Procedure V (bench handling)
Equipment Classification	Class 1 (grounded equipment)

DECLARATION OF CONFORMITY
According to ISO/IEC Guide 22 and EN 45014

Manufacturer's Name: WOODWARD GOVERNOR COMPANY (WGC)
Industrial Controls Group

Manufacturer's Address: 1000 East Drake Road
P.O. Box 3800
Fort Collins, Colorado, USA 80525-1519

European Representative's Name: WOODWARD GOVERNOR NEDERLAND BV

European Representative's Address: Hoofdweg 601
P. O. Box 34
2130 AA Hoofddorp, The Netherlands

Model Name(s)/Number(s): 2301D Digital LSSC

Conformance to Directive(s): 89/336/EEC COUNCIL DIRECTIVE of 03 May 1989 on the approximation of the laws of the member states relating to electromagnetic compatibility.
73/23/EEC COUNCIL DIRECTIVE of 19 February 1973 on the harmonization of the laws of the Member States relating to electrical equipment designed for use within certain voltage limits.

Applicable Standards: EN-50081-2, August 1993: EMC Generic Emissions Standard, Part 2: Industrial Environment.
EN 61000-6-2, April 1999: Electromagnetic Compatibility (EMC), Immunity for Industrial environments.
EN 50178, October 1997: Electronic Equipment for use in Power Installations

We, the undersigned, hereby declare that the equipment specified above conforms to the above Directive(s).

MANUFACTURER

LEGAL REPRESENTATIVE IN EUROPE

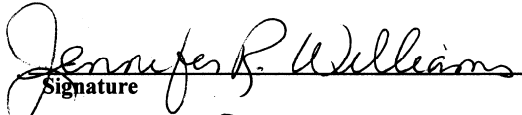
Signature

Signature

Jennifer R. Williams
Full Name

Full Name

Engineer Process/Project Manager
Position

Position

WGC, Fort Collins, CO, USA
Place

Place

6-29-00
Date

Date

We appreciate your comments about the content of our publications.

Send comments to: icinfo@woodward.com

Please reference publication **26065J**.



B26065:J



PO Box 1519, Fort Collins CO 80522-1519, USA
1000 East Drake Road, Fort Collins CO 80525, USA
Phone +1 (970) 482-5811 • Fax +1 (970) 498-3058

Email and Website—www.woodward.com

Woodward has company-owned plants, subsidiaries, and branches,
as well as authorized distributors and other authorized service and sales facilities throughout the world.

Complete address / phone / fax / email information for all locations is available on our website.