



Installation and Operation Manual



ProAct™ Digital Speed Control System for Models I and II

Manual 04121 (Revision K)

IMPORTANT



This is the safety alert symbol. It is used to alert you to potential personal injury hazards. Obey all safety messages that follow this symbol to avoid possible injury or death.

DEFINITIONS

- **DANGER**—Indicates a hazardous situation which, if not avoided, will result in death or serious injury.
- **WARNING**—Indicates a hazardous situation which, if not avoided, could result in death or serious injury.
- **CAUTION**—Indicates a hazardous situation which, if not avoided, could result in minor or moderate injury.
- **NOTICE**—Indicates a hazard that could result in property damage only (including damage to the control).
- **IMPORTANT**—Designates an operating tip or maintenance suggestion.

WARNING

The engine, turbine, or other type of prime mover should be equipped with an overspeed shutdown device to protect against runaway or damage to the prime mover with possible personal injury, loss of life, or property damage.

The overspeed shutdown device must be totally independent of the prime mover control system. An overtemperature or overpressure shutdown device may also be needed for safety, as appropriate.



Read this entire manual and all other publications pertaining to the work to be performed before installing, operating, or servicing this equipment. Practice all plant and safety instructions and precautions. Failure to follow instructions can cause personal injury and/or property damage.



This publication may have been revised or updated since this copy was produced. To verify that you have the latest revision, be sure to check the Woodward website:

www.woodward.com/pubs/current.pdf

The revision level is shown at the bottom of the front cover after the publication number. The latest version of most publications is available at:

www.woodward.com/publications

If your publication is not there, please contact your customer service representative to get the latest copy.



Any unauthorized modifications to or use of this equipment outside its specified mechanical, electrical, or other operating limits may cause personal injury and/or property damage, including damage to the equipment. Any such unauthorized modifications: (i) constitute "misuse" and/or "negligence" within the meaning of the product warranty thereby excluding warranty coverage for any resulting damage, and (ii) invalidate product certifications or listings.

NOTICE

To prevent damage to a control system that uses an alternator or battery-charging device, make sure the charging device is turned off before disconnecting the battery from the system.

NOTICE

To prevent damage to electronic components caused by improper handling, read and observe the precautions in Woodward manual 82715, *Guide for Handling and Protection of Electronic Controls, Printed Circuit Boards, and Modules*.

Revisions—Text changes are indicated by a black line alongside the text.

Woodward Governor Company reserves the right to update any portion of this publication at any time. Information provided by Woodward Governor Company is believed to be correct and reliable. However, no responsibility is assumed by Woodward Governor Company unless otherwise expressly undertaken.

© Woodward 1993
All Rights Reserved

Contents

ELECTROSTATIC DISCHARGE AWARENESS	III
CHAPTER 1. GENERAL INFORMATION.....	1
Introduction	1
Application	1
Control Applications.....	2
Speed Control Accessories	2
Actuator Accessories.....	2
CHAPTER 2. DESCRIPTION OF OPERATION	8
General	8
Control Dynamics	8
Fuel Limiters	10
Speed Reference and Ramps	12
Droop/Isochronous	14
Power Up Diagnostics	15
ProAct Actuator	15
Return Spring	16
The Feedback Device.....	16
ProAct 75 Actuator Selection	16
CHAPTER 3. INSTALLATION.....	17
Unpacking.....	17
Power Requirements	17
Control Box Location Considerations	17
Actuator Installation Considerations.....	18
Fuel Position Stops.....	18
Electrical Connections	20
Power Supply	20
Actuator and Position Feedback Wiring	22
Discrete Inputs.....	22
Speed Signal Input	24
Remote Speed Setting Input	24
Aux Voltage Input	24
Control Outputs	25
Installation Checkout Procedure	26
CHAPTER 4. OPERATION AND ADJUSTMENT	27
Introduction	27
Using the Hand Held Programmer	27
ProAct Control Menus	30
Description of Menu Set Points	32
Conclusion of Test and Calibration Procedures.....	47
CHAPTER 5. SYSTEM TROUBLESHOOTING CHARTS	48
CHAPTER 6. SERVICE OPTIONS	52
Product Service Options.....	52
Woodward Factory Servicing Options	53
Returning Equipment for Repair.....	54
Replacement Parts	54
Engineering Services.....	55
How to Contact Woodward.....	55
Technical Assistance.....	56

Contents

APPENDIX. MENU SUMMARY	57
Initial Prestart Settings.....	57
Menu 1—Dynamics Settings	57
Menu 2—Alternate Dynamics Settings.....	57
Menu 3—Speed Reference Settings	58
Menu 4—Limiter Settings	58
Menu 6—Configuration Set Points	58
ProAct Control Menu Summary.....	59
PROACT™ CONTROL SPECIFICATIONS	61

Illustrations and Tables

Figure 1-1. Flexible Coupling.....	3
Figure 1-2. ProAct Digital Speed Control and Actuator.....	3
Figure 1-3. Example of ProAct II Actuator	4
Figure 1-4. Outline Drawing of ProAct I or II Actuator	5
Figure 1-5. ProAct Wiring Diagram.....	6
Figure 1-6. Outline Drawing of ProAct Control Box.....	7
Figure 2-1. Window Width for Gain Ratio	9
Figure 2-2. Start Fuel Limit	11
Figure 2-3. Transient Overfuel.....	11
Figure 2-4. Torque Limit	12
Figure 2-5. Remote Speed Reference	14
Figure 2-6. Droop Speed Setting.....	14
Figure 2-7. ProAct Output Travel.....	15
Figure 3-1. Diesel Engine Travel Stops.....	19
Figure 3-2. Carburetor Travel Stops.....	19
Figure 3-3. Examples of Actuator Brackets.....	19
Figure 3-4. Preparing Shielded Wiring	20
Figure 3-5. Correct Wiring to Power Supply	21
Figure 3-6. Incorrect Power Supply Wiring.....	21
Figure 3-7. Speed Switch Operation	25
Figure 4-1. Hand Held Programmer (9907-205)	29
Figure 4-2. Typical Transient Response Curves	33
Figure 4-3. Non-linear Valve Power Curve.....	34
Figure 4-4. Sample Engine Plot.....	34
Figure 4-5. Linearized Engine Plot	35
Figure 4-6. Example of Plot Created from GAIN Column	37
Figure 4-7. Example of Plot Created from ACTUATOR OUTPUT Column.....	37
Figure 4-8. Accel/Decel Example	40
Figure 4-9. Droop Curve.....	41
Figure 4-10. Idle Droop.....	42
Figure 4-11. Speed Switch Settings	42
Figure 4-12. Torque Limit Map	44
Figure 4-13. Dynamics Map Curves.....	46

Electrostatic Discharge Awareness

All electronic equipment is static-sensitive, some components more than others. To protect these components from static damage, you must take special precautions to minimize or eliminate electrostatic discharges.

Follow these precautions when working with or near the control.

1. Before doing maintenance on the electronic control, discharge the static electricity on your body to ground by touching and holding a grounded metal object (pipes, cabinets, equipment, etc.).
2. Avoid the build-up of static electricity on your body by not wearing clothing made of synthetic materials. Wear cotton or cotton-blend materials as much as possible because these do not store static electric charges as much as synthetics.
3. Keep plastic, vinyl, and Styrofoam materials (such as plastic or Styrofoam cups, cup holders, cigarette packages, cellophane wrappers, vinyl books or folders, plastic bottles, and plastic ash trays) away from the control, the modules, and the work area as much as possible.
4. Do not remove the printed circuit board (PCB) from the control cabinet unless absolutely necessary. If you must remove the PCB from the control cabinet, follow these precautions:
 - Do not touch any part of the PCB except the edges.
 - Do not touch the electrical conductors, the connectors, or the components with conductive devices or with your hands.
 - When replacing a PCB, keep the new PCB in the plastic antistatic protective bag it comes in until you are ready to install it. Immediately after removing the old PCB from the control cabinet, place it in the antistatic protective bag.

NOTICE

To prevent damage to electronic components caused by improper handling, read and observe the precautions in Woodward manual 82715, *Guide for Handling and Protection of Electronic Controls, Printed Circuit Boards, and Modules*.

Chapter 1.

General Information

Introduction

This manual describes the Woodward ProAct™ Digital Speed Control and ProAct 75 degree electric powered actuators, models I and II.

Application

The ProAct control system is designed to control the speed of engines in mechanical drive or generator set service. The electric powered ProAct actuator has 75° of rotation and is designed for direct drive of the butterfly valve on gas engines, and through linkage the racks on diesel engines.

Actuators are available in different sizes to fit specific control demands. In most cases, the ProAct II actuator will be used. The ProAct II provides 6.8 J (5.0 ft-lb) of work (transient) and 2.7 N·m (2.0 lb-ft) of torque.

The ProAct I is extremely fast and provides 3.4 J (2.5 ft-lb) of work (transient) and 1.4 N·m (1.0 lb-ft) of torque at steady state. ProAct I controls may be operated on nominal 12 Vdc systems. ProAct II controls require nominal 24 Vdc supply.

Larger output ProAct III and ProAct IV controls are available. Information on these actuators is in manual 04127.

The ProAct Digital Speed Control includes an input for a 4 to 20 mA remote speed reference setting, an internal speed reference for local control of speed, and an auxiliary voltage input for load-sensor connection in load-sharing applications. A fuel limiting version is also available.

The ProAct control system includes:

- a ProAct Digital Speed Control
- an external 18–32 Vdc (24 Vdc nominal) power source for Model II or a 10–32 Vdc power source for Model I
- a speed-sensing device (MPU)
- a ProAct I or ProAct II actuator to position the fuel rack
- a hand held terminal for adjusting control parameters
- an optional load sensing device

The ProAct Digital Speed Control (Figure 1-2) consists of a single printed circuit board in a sheet metal chassis. Connections are via two terminal strips and a 9-pin J1 connector.

The control chassis has an aluminum shield to protect the circuits from electromagnetic interference (EMI) and electrostatic discharge (ESD).

Control Applications

The ProAct II control requires 18–32 Vdc (24 Vdc nominal) uninterrupted power supply, with 125 watts as the maximum power consumption at rated voltage. ProAct I requires 8–32 Vdc (12 or 24 Vdc nominal) uninterrupted power supply with 50 W as the maximum power consumption at rated voltage.

ProAct actuators are designed to directly link to the butterfly in the gas engine carburetor. The control can be programmed to have variable gain to compensate for the variable gain characteristics of carbureted gas engines.

Diesel engine applications can use the control programmed to accommodate non-linear fuel controls or non-linear linkage arrangements.

Speed Control Accessories

Hand Held Programmer (Figure 4-1, part number 9907-205) is used to adjust the ProAct control. It plugs into the serial port (J1 connector) of the control.

Generator Load Sensor (part number 9907-026) for load sharing or droop-parallel generator applications. This will connect to the Aux input on the control.

SPM-A Synchronizer for synchronizing the generator phase to that of the power bus. The synchronizer generates a close-generator-breaker signal to parallel the generator with the power bus. Connect the synchronizer to the Aux input to bias the speed setting.

Actuator Accessories

Electrical plug to match plug on the actuator:

- 1631-187 straight plug
- 1631-633 90° plug

Actuator Lever for linkage connection:

- 3699-027 5-inch, 5 holes
- 3952-043 2-inch, 2 holes

Flexible Couplings for direct connection of the actuator output to a carburetor's butterfly-valve shaft (dimension "X" in Figure 1-1):

Diameter of Butterfly Valve Shaft	Part Number
0.250	1431-431
0.312	1431-433
0.375 (9.5 mm)	1431-435
0.394 (10 mm)	1431-437
0.472 (12 mm)	1431-439
0.500	1431-443
0.625	1431-445
0.750	1431-447
0.875	1431-449

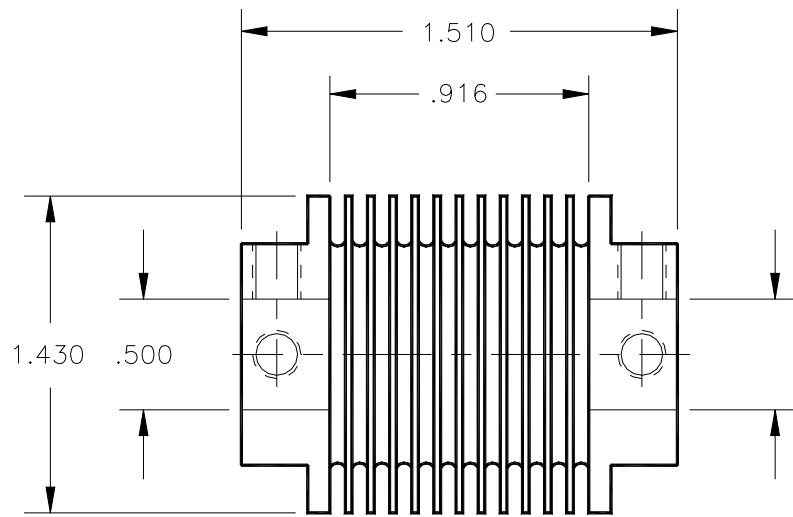

041-087
93-4-8 RAM

Figure 1-1. Flexible Coupling

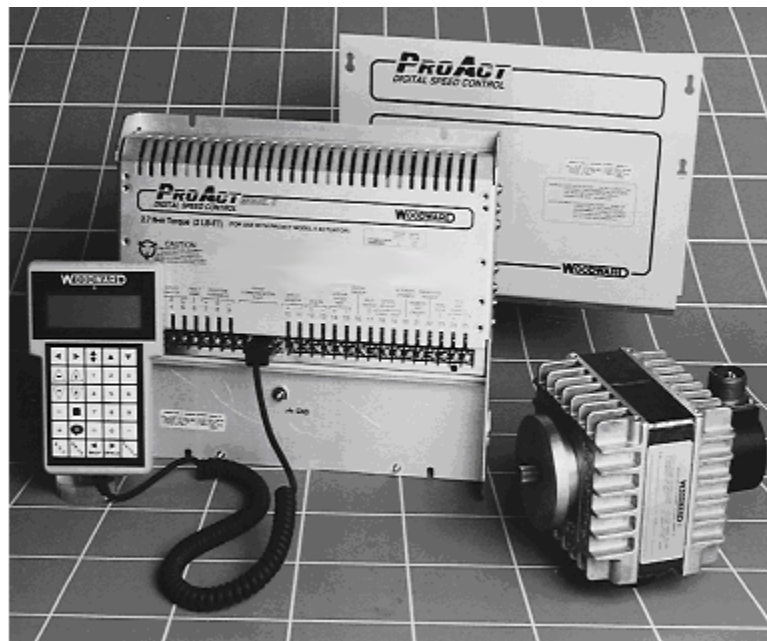

Figure 1-2. ProAct Digital Speed Control and Actuator

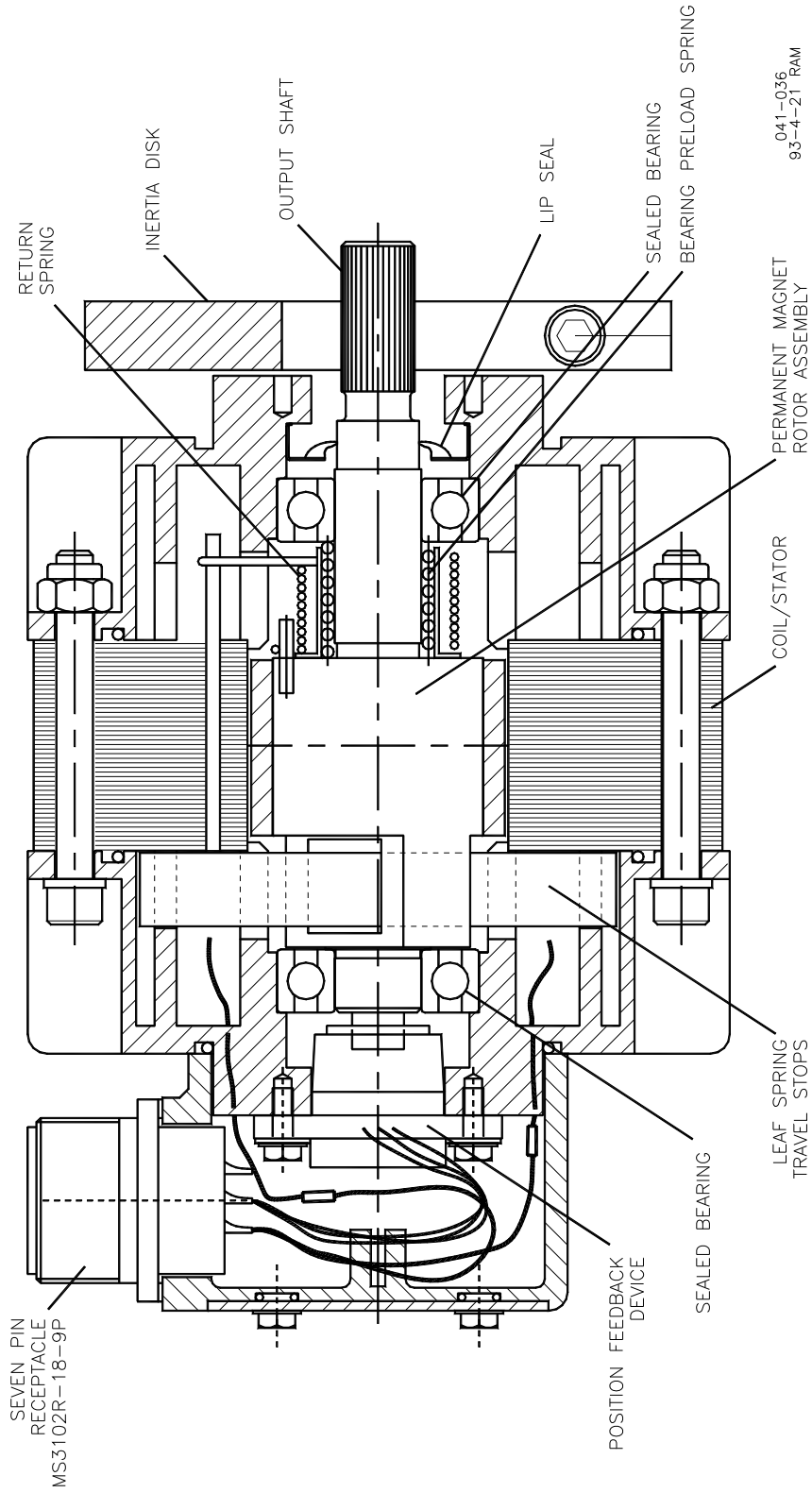

Figure 1-3. Example of ProAct II Actuator

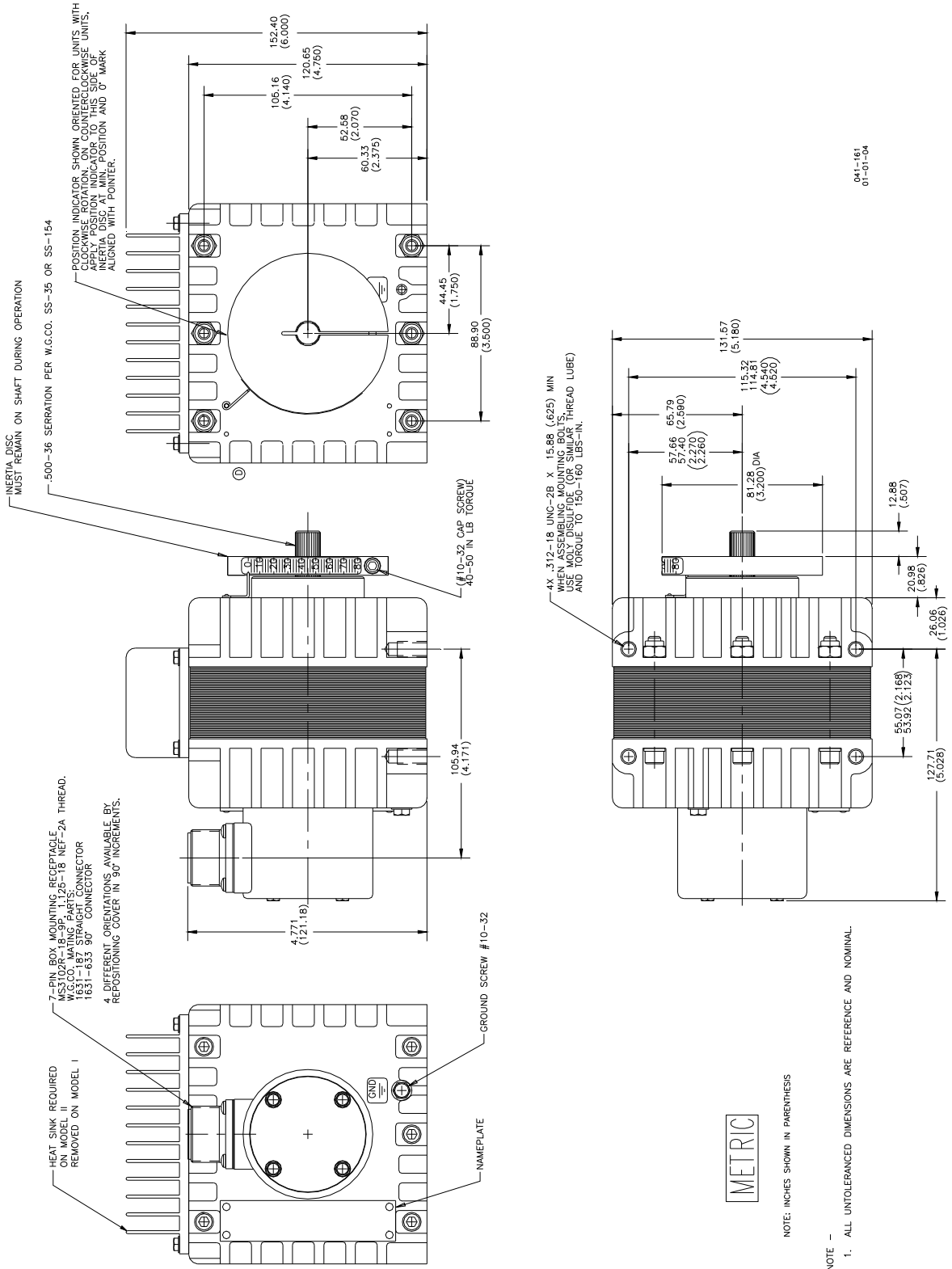
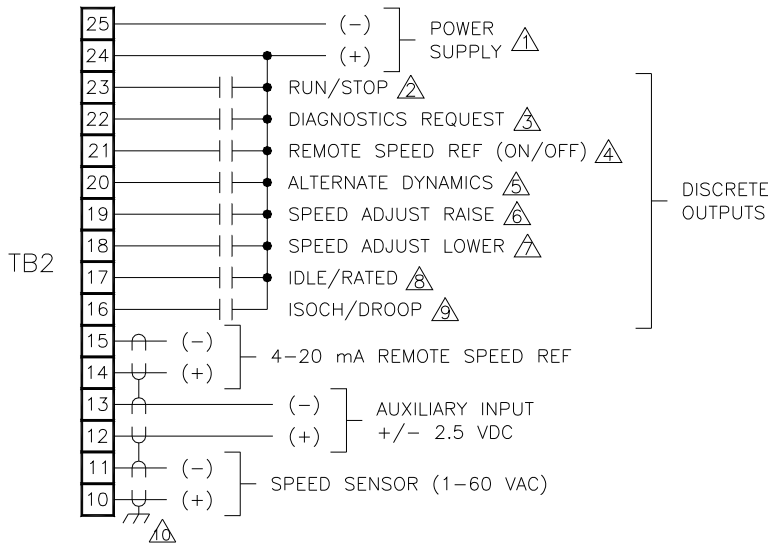
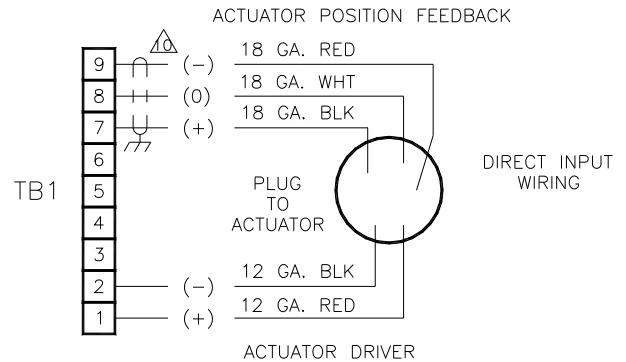
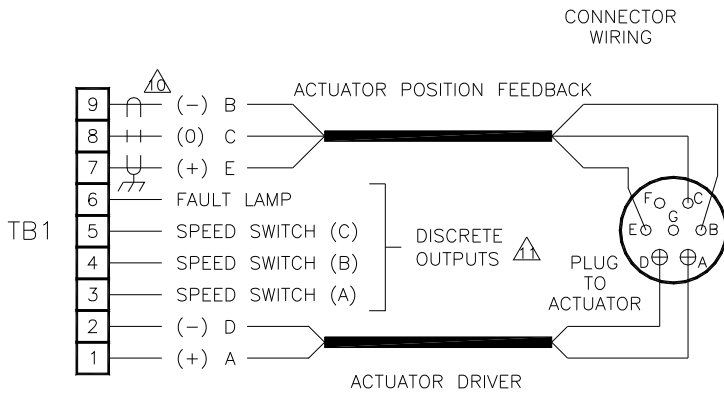
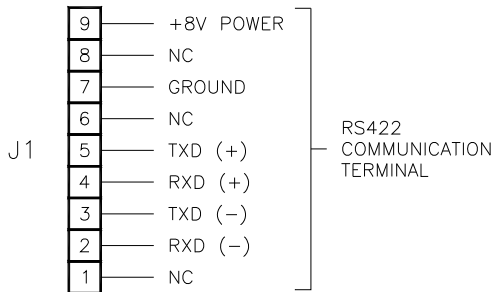

Figure 1-4. Outline Drawing of ProAct I or II Actuator



NOTES:

- ⚠ MODEL I CONTROL: 8-32 VDC
MODEL II CONTROL: 18-32 VDC
- ⚠ CLOSE TO RUN.
WARNING: DO NOT USE FOR EMERGENCY SHUTDOWN. THE PRIME MOVER SHOULD BE EQUIPPED WITH A SEPARATE OVERSPEED, OVERTEMPERATURE OR OVERPRESSURE SHUTDOWN DEVICE(S) TO PROTECT AGAINST RUNAWAY OR DAMAGE TO THE PRIME MOVER WITH POSSIBLE PERSONAL INJURY OR LOSS OF LIFE.
- ⚠ FACTORY USE ONLY.
- ⚠ CLOSE FOR REMOTE REF.
- ⚠ CLOSE FOR ALTERNATE DYNAMICS.
- ⚠ CLOSE TO RAISE SPEED REF.
- ⚠ CLOSE TO LOWER SPEED REF.
- ⚠ CLOSE FOR RATED.
- ⚠ CLOSE FOR ISOCH.
- ⚠ SHIELDED WIRES TO BE TWISTED, WITH SHIELD GROUNDED AT ONE END ONLY. WHEN MOUNTING CONTROL TO BULKHEAD, USE EXTERNAL TOOTH LOCK WASHER UNDER ONE SCREWHEAD TO ENSURE PROPER GROUNDING.
- ⚠ OUTPUT WILL SINK UP TO 0.5 AMPERE AT POWER SUPPLY VOLTAGE. THE OUTPUT IS A LOW SIDE SWITCH TO THE NEGATIVE OR THE POWER SUPPLY.



PLANT WIRING

STANDARD CONTROLS

041-093
01-4-16

Figure 1-5. ProAct Wiring Diagram

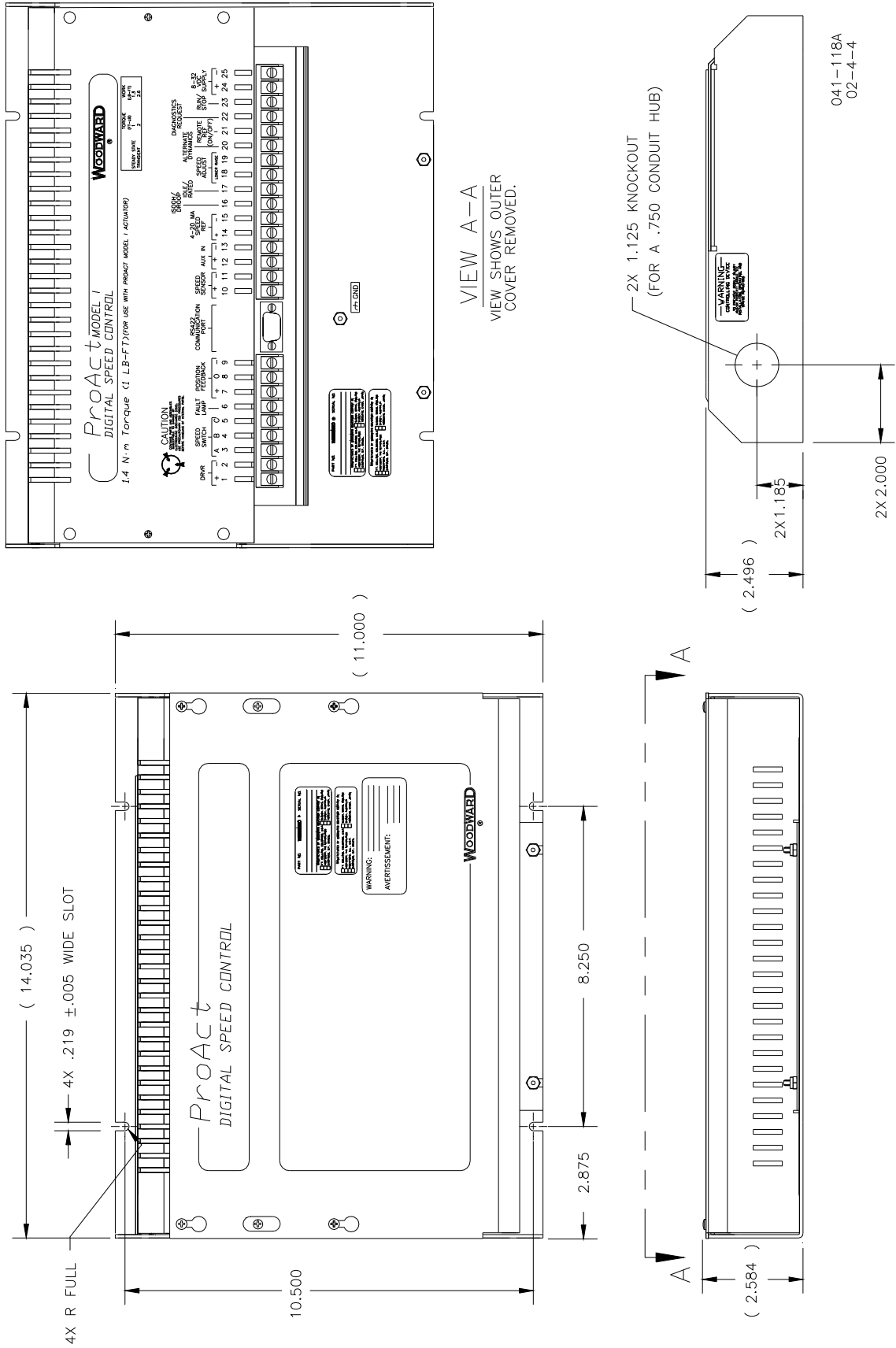

Figure 1-6. Outline Drawing of ProAct Control Box

Chapter 2. Description of Operation

General

This chapter provides an overview of the features and operation of the ProAct™ Digital Speed Control and Actuator system. Figure 1-4 shows the actuator outline. Figure 1-5 is the wiring diagram for reference in the following descriptions. Figure 1-3 is a schematic cutaway view of the ProAct II actuator.

The ProAct Digital Speed Control uses a 16-bit microprocessor for all control functions, such as computing engine speed, performing the control algorithm calculations, speed ramps, etc. All control adjustments are made with a hand held terminal/display (see Figure 4-1) that communicates with the control via a serial port. The terminal/display is disconnected from the control when not in service to provide security against tampering.

The operating program is adjusted through seven menus accessed through the hand held terminal display. Details of these seven menus are contained in Chapter 4 of this manual.

The speed sensor contains a special tracking filter, designed for reciprocating engines, which minimizes the effects of engine torsionals or irregularities in the gear used for sensing speed. This provides exceptionally smooth steady-state control and allows the control dynamics to be matched to the engine.

The speed signal itself is usually provided by a magnetic pickup supplying an AC signal from 1 to 60 Vrms to the control. The frequency (in Hz) is proportional to engine rpm.

The control features exceptional spike, ripple, and EMI (electromagnetic interference) rejection. Discrete inputs are optically isolated and capable of rejecting EMI and variable resistances in switch or relay contacts. Analog inputs are differential-type with extra filtering for common-mode noise rejection. This protects the control from spurious interference and noise which can cause speed and load shifts. The chassis should be bolted to a good ground to ensure effective EMI/RFI protection.

An auxiliary ± 2.5 volt input is provided to interface with Woodward Load Sensors, to provide isochronous load-sharing operation.

Control Dynamics

The algorithms used in the ProAct control are designed specifically for reciprocating engine applications. Control dynamics vary automatically as functions of both speed and actuator position to provide better performance over the entire engine operating range.

Alternate Dynamics

The ProAct control provides two complete sets of dynamic adjustments, which are externally switch selectable. The two sets of dynamics are provided for use where engine operating conditions change, such as in systems which use two different fuels, clutched-in loads, and electrical power generation where the unit may be operated stand-alone and paralleled with an infinite bus.

Each set of dynamics provides different gain mapping, stability, compensation, gain ratio, and gain window settings. This allows instantaneous changes in control for engines which operate with different fuels or have load-type changes which require different dynamics.

Gain Ratio is the ratio of Gain setting during transient off-speed conditions to the gain setting at steady state. Speed Gain Ratio operates by multiplying the Gain set point by the Gain Ratio when the speed error is anticipated to be greater than the Window Width. This allows a lower gain at steady state for better stability and reduced steady-state actuator movement (see Figure 2-1).

DUAL GAIN DYNAMICS SPEED CONTROL

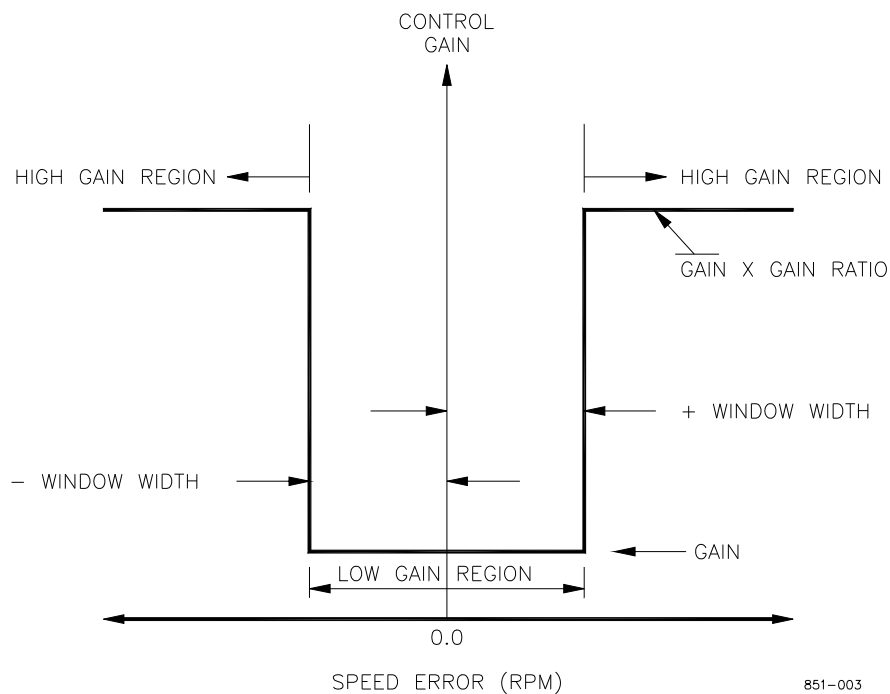

851-003
97-08-22

Figure 2-1. Window Width for Gain Ratio

During steady-state operation with a constant load, the control uses the base gain setting. This gain is adjusted by the user to a value to prevent the control from responding to minor fluctuations in engine speed, a common problem with gas-fuel, spark-ignited engines.

This feature eliminates the potentially damaging jiggle of the actuator and fuel system. The control automatically increases gain by an adjustable gain ratio when speed error exceeding an adjustable window occurs, or is anticipated to occur, based on measurements of the instantaneous rate of change of the engine. Operation with base gain is restored once the control senses the return to steady-state speed. The Window Width speed is a \pm value, centered around zero speed error.

Variable Dynamics

The control is designed to compensate for non-linear fuel systems and changes in engine dynamics with load. The control gain is mapped as a function of actuator position.

Four break points work with four gain settings to map the actuator against expected non-linear conditions. This provides optimal dynamics and smooth steady-state operation for all conditions from no load to full engine load. The four different response rates are achieved by the creation of four different gain settings. Gas engine installations will usually require all four gain settings for different fuel flows, especially if the actuator is direct-coupled to the butterfly. Most diesel applications will need only one or two of the gain settings with the break points of the other settings moved up out of the way (set to 100%).

Fuel Limiters

Start Fuel Limit

The ProAct control has a start fuel limiter to provide smoother transitions and less over-fueling during start-up. The limiter is set to provide the desired position during starts. The control will reduce the fuel when the start speed set point is reached as required to control engine speed, but will not exceed the Start Limit. The Start Fuel limit is removed when the engine speed reaches the Start Speed set point.

The Start Fuel limit is combined with a user-tunable ramp that will increase the Start Fuel limit at a programmable rate while the engine speed is below the Start Speed set point. This ramp is designed to allow for easier starting of the engine during various temperature conditions, such as a cold start, which may require an increase in fuel.

Maximum Fuel Limit

This programmable actuator position limit is in place when rated speed is selected. This is the maximum actuator position setting allowed for steady-state full load.

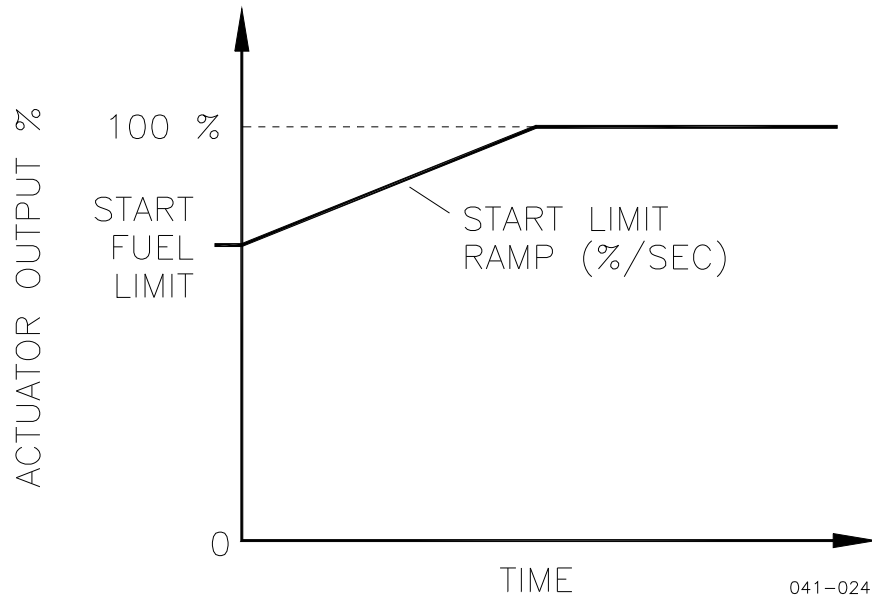

Figure 2-2. Start Fuel Limit

Transient Overfuel

This feature allows the user to set the Maximum Fuel Limit near the rated engine horsepower. The Transient Overfuel will allow exceeding this Maximum Fuel Limit for a tunable percentage for a tunable time (Transient Time). This ensures good transient load acceptance while maintaining safe steady-state-horsepower limiting.

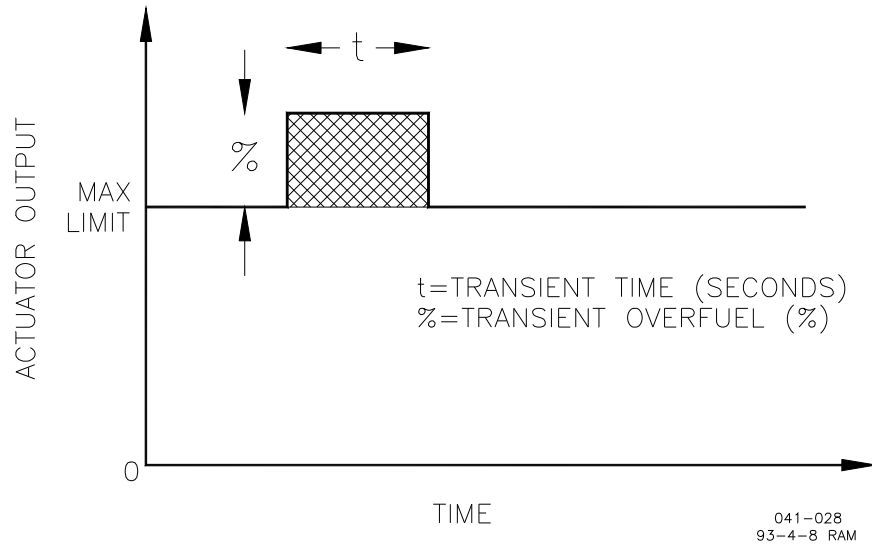

Figure 2-3. Transient Overfuel

When Rated Speed is selected by closing the Idle/Rated switch contact, the fuel limit is set to the Maximum Fuel Limit set point value or the Torque Limit, whichever is less, for the current engine operating speed. The speed reference selected at this time is determined by the status of the Enable Remote switch. If Remote reference is not selected (the Remote reference switch contacts are open), the speed reference will ramp from low idle to rated speed, based on the Accel Time set point. Closing either the Raise or Lower contacts (or the Remote contacts) while ramping from idle to rated results in immediate cancellation of the idle-to-rated ramp. The Raise/Lower ramp rates will take over, depending on whether Raise or Lower is selected.

The Raise and Lower commands ramp engine speed based on the Raise and Lower Rate set points. The Raise and Lower Limits determine the limits of these commands. If Enable Remote is selected (and Rated Speed is selected), the control will ramp speed to the reference value set by the remote speed-setting milliamp input (at the Raise or Lower Rate). The remote speed setting operates from 4 to 20 mA. The values of the 4 mA and 20 mA Remote Reference set points must be set between the Raise and Lower Limit set points. The 4 mA Remote Reference set point may be set to a lower or higher speed than the 20 mA set point, providing for either direct or reverse-acting remote speed setting.

If Remote is selected when the Idle/Rated switch contacts are closed, or during the idle-to-rated ramp, the speed reference will ramp to the speed reference value determined by the milliamps on the remote speed-setting input, based on the Raise Rate/Lower Rate set points.

Remote speed-setting inputs between 2 and 4 mA are treated as the minimum of 4 mA. Below 2 mA, the remote input is considered failed. Between 4 and 20 mA, the control determines the required speed reference based on a straight line interpolated between the 4 mA Remote Reference and 20 mA Remote Reference set points. If a difference is detected between the current speed reference and the remote reference computed from the mA input, the current speed reference is raised or lowered at the rate determined by the Raise or Lower Rate to bring the speed reference into agreement with the remote speed reference. The remote reference will not increase speed over the Raise Limit or lower it below the Lower Limit, nor change speed faster or slower than the Raise Rate/Lower Rate respectively.

When Remote Reference is selected and the remote input is failed (less than 2 mA), the speed reference remains at the current value. The speed reference can be changed in this situation only by increasing the remote reference above 2 mA or by opening the Remote Enable switch and toggling the Run/Stop switch or cycling the power to the control (cycling the power is *not* recommended).

When the current operating mode is Rated, switching to Idle results in ramping engine speed to idle based on the Decel Time set point.

If the control is in Remote Speed Reference and you wish to return to Rated Speed, the Remote switch must be in the open position and the Run/Stop switch toggled (or cycle the power to the control, which is *not* recommended).

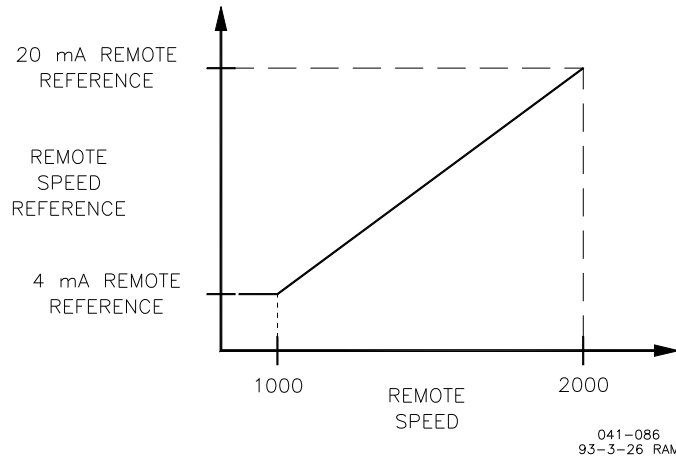

Figure 2-5. Remote Speed Reference

Droop/Isochronous

The Droop/Isochronous switch allows selection of either type of governor operation. If Droop is selected, the ProAct control will hold engine speed according to a droop schedule entered in the program.

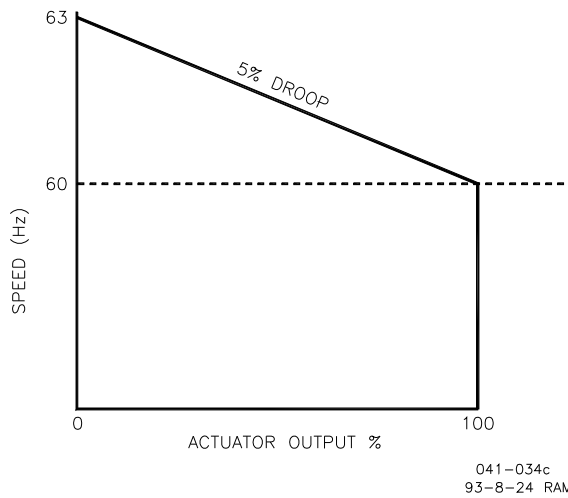

Figure 2-6. Droop Speed Setting

The droop schedule is based on a full 75 degrees of actuator rotation between minimum and maximum fuel. If less than 75 degrees of rotation is used, the amount of droop is reduced proportionally. Thus a control programmed for 5% droop will actually only have 2.5% droop if only 37.5° of actuator rotation is used, from no load to full load. Using only 37.5° of actuator travel will require programming 10% droop for an actual 5% droop curve (a minimum of 66° of travel is recommended).

Power Up Diagnostics

The Power Up Diagnostics feature is provided to verify the proper operation of the microprocessor and memory components. The diagnostics take about ten seconds after the control is powered on. A failure of the test will turn off the output of the control. The ProAct control will not increase actuator signal from zero until diagnostics are complete.

ProAct Actuator

The ProAct actuator is a limited-angle rotational torque motor designed specifically for the control of engine fuel. The torque motor is a “run-hold” device. It responds to a fuel-position error at full speed until the position feedback causes the electronic control to change the current signal to hold position. This characteristic makes the actuator extremely fast and at the same time extremely accurate and “stiff” in engine-fuel control.

The ProAct II uses a four-pole torque motor design to provide 2.7 N·m (2.0 lb-ft) of torque (3.4 J/2.5 ft-lb work) with 6 A, 24 V input at steady state, and 5.4 N·m (4.0 lb-ft) of torque (6.8 J/5.0 ft-lb work) with 12 A, 24 V input during transient.

The actuator is equipped with internal stop springs which allow rotational overshoot of 3° in each direction. The internal spring stops are necessary to halt the rotation of rotor and load inertia without damage to the actuator. This possible over-rotation of 3° in both directions must be considered when designing linkage or connecting to the butterfly shaft.

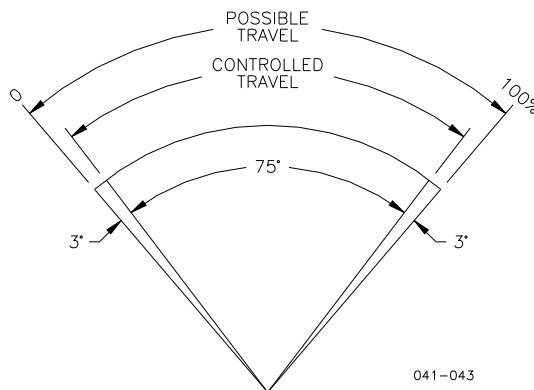

Figure 2-7. ProAct Output Travel

The terminal shaft on the actuator provides 0.500-36 (inch) serrations. The output shaft is connected to the butterfly valve or fuel control shaft either directly through a zero-backlash flexible coupling* or through an attached lever and linkage. Installations should attempt to use as much of the actuator rotation as possible to use as much of the actuator's work capability as possible.

*—When a flexible coupling is used, take care to assure that the maximum coupling misalignment is not exceeded and that the coupling is sized properly for the loads.

Return Spring

The ProAct actuator has an internal return spring designed to move the actuator toward minimum fuel in case the electrical control should fail, or power is removed. Spring scale may not be enough to move the engine to shutdown.

WARNING

The fuel system should be equipped with a spring return to minimum fuel capable of moving the fuel control in case of failure in the ProAct system, the connections between the ProAct actuator and the fuel control, or loss of electrical power. The return spring should be of sufficient force to return the fuel system to minimum fuel on loss of actuator control, but should not limit the actuator's ability to properly control the engine under all operating conditions.

The Feedback Device

The ProAct actuator uses a brushless, magneto-resistive position sensor. The position feedback signal to the digital control is responsible for the accurate positioning of the actuator.

ProAct 75 Actuator Selection

The actuator installed must match the system requirements. Select the actuator with either an MS connector or a conduit fitting with clockwise or counterclockwise rotation*.

*—Directions are determined by looking at the actuator shaft and the rotation to increase fuel.

Chapter 3. Installation

Unpacking

Before handling the control, read page iii, Electrostatic Discharge Awareness. Be careful when unpacking the electronic control. Check the control for signs of damage such as bent panels, scratches, and loose or broken parts. If any damage is found, immediately notify the shipper.

The ProAct™ actuator will come in a separate carton from the control. Inspect the carton for damage. The actuator is a rugged, heavy device and shipping damage is unlikely. Particularly inspect the receptacle and terminal shaft for possible damage.

Power Requirements

The ProAct II control system requires a voltage source of 18 to 32 Vdc (24 Vdc nominal) uninterrupted power supply. Maximum power consumption is 125 W at rated voltage. The ProAct I system requires a voltage source of 8 to 32 Vdc (12 or 24 Vdc nominal). Maximum power consumption is 50 W at rated voltage.

NOTICE

To prevent damage to the control, do not exceed the input voltage range.

IMPORTANT

If a battery is used for operating power, an alternator or other battery charging device is necessary to maintain a stable supply voltage.

NOTICE

To prevent damage to the control, make sure that the alternator or other battery-charging device is turned off or disconnected before disconnecting the battery from the control.

Control Box Location Considerations

Consider these requirements when selecting the mounting location for the ProAct control:

- adequate ventilation for cooling
- space for servicing and repair
- 54 inches (1.4 m) of connecting cord is provided with the Hand Held Programmer. If the location does not allow comfortable use of the programmer, an extension cord should be obtained at the time of installation. The RS-422 communications will allow a lengthy extension cord.
- protection from direct exposure to water or condensation-prone environment
- protection from high-voltage or high-current devices, or devices which produce electromagnetic interference
- avoidance of vibration
- selection of a location that will provide an operating temperature range of -40 to $+70$ °C (-40 to $+158$ °F).

The Digital Speed Control must NOT be mounted on the engine.

Actuator Installation Considerations

Thermal

The actuator is designed for installation on the engine. The actuator will generate heat, especially when stalled.

The feedback sensor located on the actuator has a maximum temperature limitation of 125 °C (257 °F). Should the actuator be shielded from air circulation, the installer must consider the heat conductivity of the installation bracket, and the operating temperature of the ultimate heat sink to which the bracket will be attached. Generally the heat transfer abilities of aluminum and low-carbon steel are better than high-carbon steel or stainless steel. Contact Woodward if operating temperature is a concern.

Output Coupling or Linkage

The actuator will provide up to 75° rotation from minimum to maximum positions. This will allow direct installation to most butterfly shafts. Special connectors that permit the installation of the actuator directly to a butterfly valve shaft are available. The coupling selected (or any linkage used) must be of zero backlash design. If a coupling is used it should be drilled and pinned, or serrated.

The bracket that mounts the actuator must be of adequate precision to assure that misalignment limits of the coupling used are not exceeded. Contact Woodward for help in selection of an approved coupling.

Diesel engines will generally useless rotation, often about 30 degrees. Linkage should be designed to use as much actuator rotation as possible to take advantage of the actuator's full work capability. (If only 30 degrees of actuator rotation is used, the actuator will provide only 40 percent of its work capability.)

Fuel Position Stops

Diesel installations will generally use the fuel system minimum and maximum position stops. The actuator travel should be centered within the total rotation needed from minimum to maximum fuel.

Diesel engine racks are normally designed to provide the minimum and maximum stops without binding.

Butterfly valves in carburetors will often bind if rotated too far toward minimum or maximum. For this reason, the stops in the actuator should be used at both minimum and maximum positions. Note that the stops will allow up to 3° of additional rotation in both directions during impact.

Make sure that the engine will always shut down when the actuator is at the minimum stop.

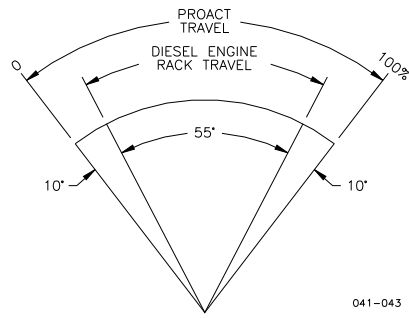

Figure 3-1. Diesel Engine Travel Stops

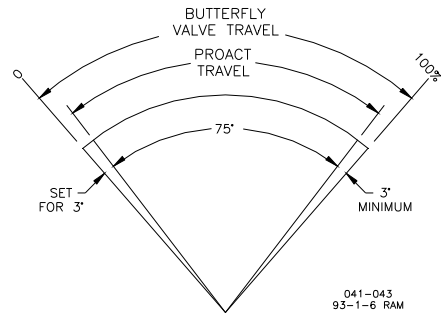
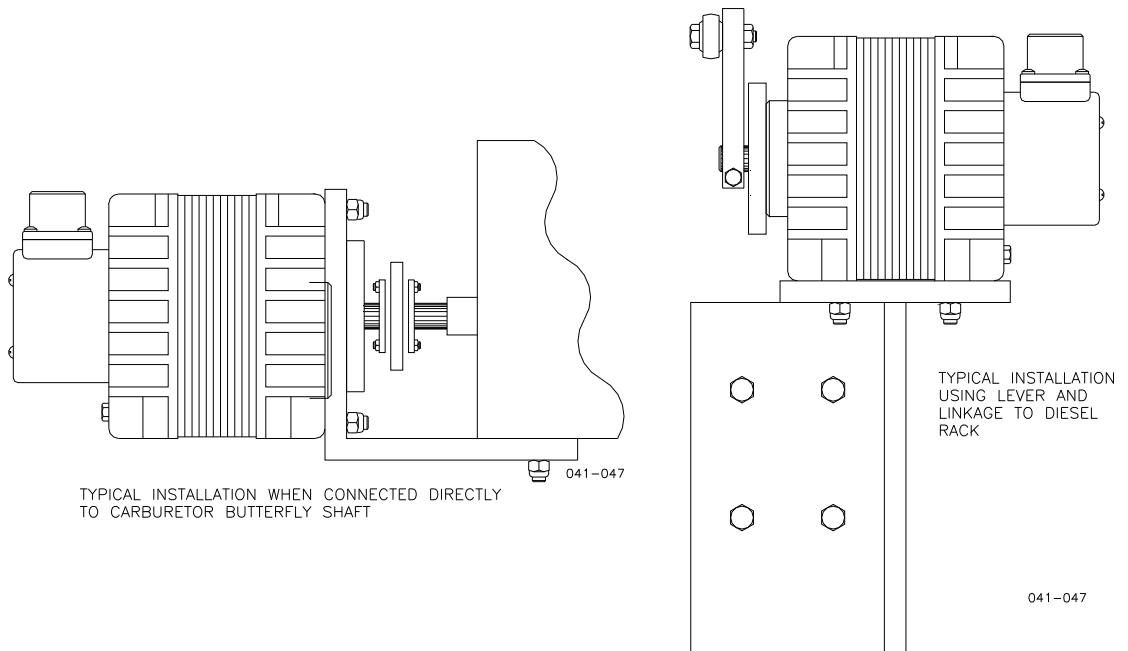

Figure 3-2. Carburetor Travel Stops

Actuator Bracket

The actuator may be installed on a bracket holding to the 2.248–2.251 inch diameter male pilot concentric to the terminal shaft or to a bracket which attaches to the base with four .312-18 screws with a minimum engagement of 16 mm (0.625 inch). The actuator may be mounted in any attitude. The actuator is weather proof and resistant to the corrosive effects of water and salt water, however pressure washing of the feedback device side of the actuator should be minimized.



Replace the four outside through bolts with longer .250-20 bolts when mounting on a fixture locating on the pilot diameter. Torque the bolts to 7.3 to 8.5 N-m (65 to 75 lb-in).

NOTICE

The actuator will fall apart if the inner bolts are removed.

When mounting on the bottom of the actuator, torque the attaching bolts to 17 to 18 N-m (150 to 160 lb-in).

Figure 3-3. Examples of Actuator Brackets

Electrical Connections

External wiring connections and shielding requirements for a typical control installation are shown in the wiring diagram. The wiring connections are explained in the rest of this chapter.

Shielded Wiring

All shielded cable must be twisted conductor pairs. Do not attempt to tin the braided shield. All signal lines should be shielded to prevent picking up stray signals from adjacent equipment. Connect the shields to the nearest chassis ground. Wire exposed beyond the shield should be as short as possible, not exceeding 50 mm (2 inches). The other end of the shields must be left open and insulated from any other conductor. **DO NOT** run shielded signal wires along with other wires carrying large currents. See Woodward manual 50532, *EMI Control for Electronic Governing Systems*, for more information.

Where shielded cable is required, cut the cable to the desired length and prepare the cable as instructed below.

1. Strip outer insulation from **BOTH ENDS**, exposing the braided or spiral wrapped shield. **DO NOT CUT THE SHIELD.**
2. Using a sharp, pointed tool, carefully spread the strands of the shield.
3. Pull the inner conductor(s) out of the shield. If the shield is the braided type, twist it to prevent fraying.
4. Remove 6 mm (1/4 inch) of insulation from the inner conductors.

The shield must be considered as a separate circuit when wiring the system. The shield must be carried through connectors without interruption.

Installations with severe electromagnetic interference (EMI) may require additional shielding precautions. Contact Woodward for more information.

Failure to provide shielding can produce future conditions which are difficult to diagnose. Proper shielding at the time of installation is required to assure satisfactory operation of the speed control system.

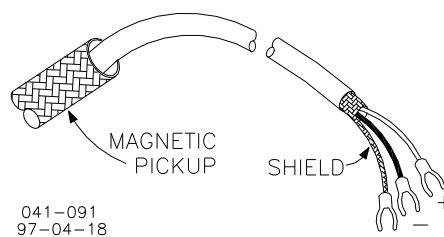
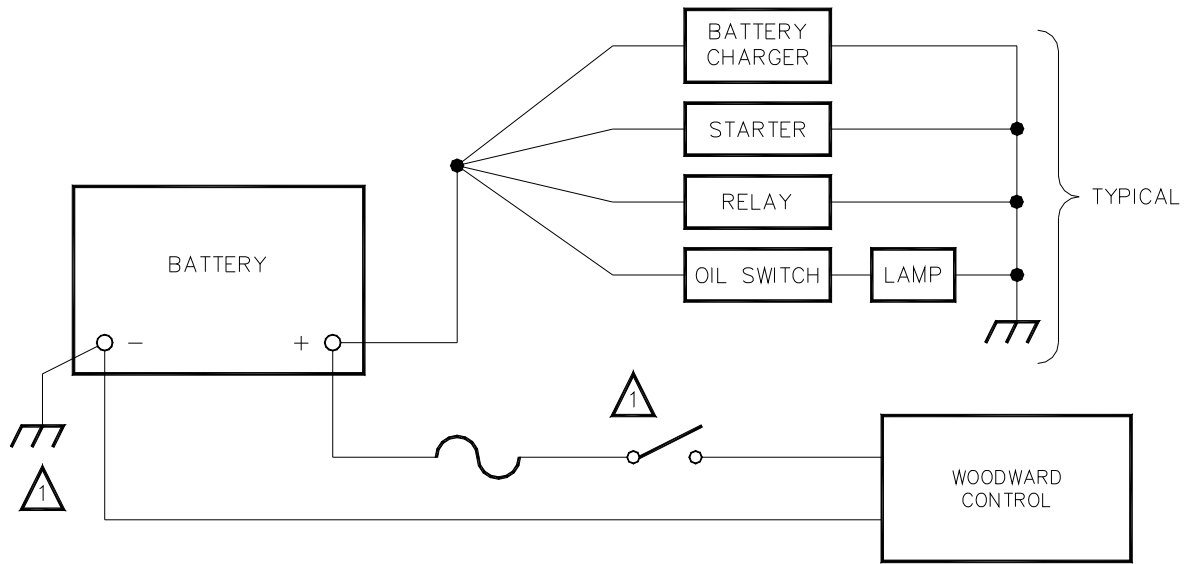

Figure 3-4. Preparing Shielded Wiring

Power Supply

The power supply output must be low impedance (for example, directly from batteries).



RIGHT

NOTE:

 A NEGATIVE GROUND SYSTEM IS SHOWN. IF A POSITIVE GROUND SYSTEM IS USED, THE SWITCH AND FUSE MUST BE LOCATED IN SERIES WITH BATTERY (-) AND TERMINAL (TB1-2) ON THE WOODWARD CONTROL. THE POSITIVE TERMINAL BECOMES CHASSIS GROUND.

Figure 3-5. Correct Wiring to Power Supply



WRONG

824-143
97-08-22 skw

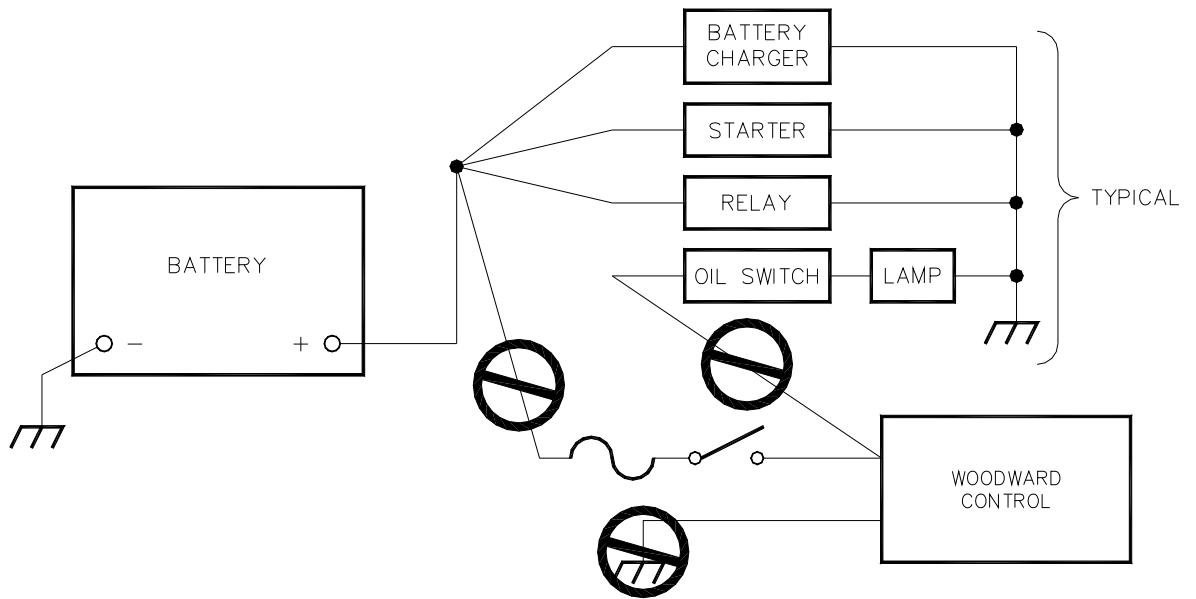
Figure 3-6. Incorrect Power Supply Wiring

Run the power leads directly from the power source to the control. DO NOT POWER OTHER DEVICES WITH LEADS COMMON TO THE CONTROL. Avoid long wire lengths. Connect the positive (line) to terminal 24 and the negative (common) to terminal 25. If the power source is a battery, be sure the system includes an alternator or other battery-charging device.

DO NOT turn off control power as part of a normal shutdown procedure. Use the Run/Stop discrete input (terminal 23) for normal shutdown.

NOTICE

Do NOT apply power to the control at this time. Applying power may damage the control.

NOTICE

To prevent damage to the engine, apply power to the ProAct control for at least ten seconds before starting the engine. The control must have time to perform its power-up diagnostics and become operational. Do not attempt to start the engine if the diagnostic tests fail, because test failure turns off the output of the control.

NOTICE

To prevent possible damage to the control or poor control performance resulting from ground loop problems, follow the electrical connection instructions. The control common is electrically isolated from the power supply input.

Actuator and Position Feedback Wiring

The ProAct actuator will rotate in either direction. In models I and II, the actuator direction of rotation is selected by wiring in the actuator and the drift spring.

Connect the actuator wiring from the actuator to the ProAct control to terminals 1 (+) and 2 (-). Connect the actuator position feedback wires to terminals 7 (+), 8 (0), and 9 (-). Position feedback nominal voltages are approximately 3 V at minimum actuator position and 2 V at maximum actuator position.

Discrete Inputs

Discrete inputs are the switch input commands to the ProAct Digital Speed Control. The discrete inputs are usually powered by the positive power supply.

Isoch/Droop Contact

The Isoch/Droop contact (open for droop, closed for isochronous) connects to terminal 16. When terminal 16 is open, the ProAct control will operate in droop at the percentage entered in menu 3. When closed, the control will operate in isochronous.

The percent of droop entered in Menu 3 is based on 75° of actuator rotation between minimum and maximum positions. If the installation uses less than 75°, the amount of droop must be increased proportionally.

Idle/Rated Contact

The Idle/Rated contact (open for Idle, closed for Rated) connects to terminal 17. When the Idle/Rated contact is closed, the control immediately switches the fuel limit to the maximum limit or torque limit (whichever is less) and ramps engine speed to the rated speed set point (or the speed specified by the Remote Input when the Remote Speed Setting input at terminal 21 is enabled). When the Idle/Rated contact is opened, the control ramps engine speed to the idle speed setting.

The idle set point cannot be set above the rated set point. The fuel limiters (start, torque, and maximum) remain effective regardless of the Remote Reference input.

Lower and Raise Speed Contacts

The Lower Speed contact connects to terminal 18. Raise and Lower inputs are effective only if the control is in Rated. When the Lower Speed contact is closed, the control lowers speed at a rate determined by the Lower Rate set point. When the contact is open, speed remains at its current value. Closing the Lower Speed contact will cancel the ramps started by the Idle/Rated contact.

The Raise Speed contact connects to terminal 19. When the Raise Speed contact is closed, the control raises speed at a rate determined by the Raise Rate set point. When the contact is open, speed remains at its current value. Closing the Raise Speed contact will cancel the ramps started by the Idle/Rated contact.

Closing both Raise and Lower contacts at the same time will disable Raise and Lower speeds as long as both contacts are closed.

The Raise and Lower Speed contacts are disabled when the Remote Speed Setting mode is selected.

Alternate Dynamics

The Alternate Dynamics contact connects to terminal 20. When this contact is open, Dynamics set 1 is selected. When this contact is closed, Alternate Dynamics is selected.

Remote Reference

When Remote Reference is selected by closing the contacts to terminal 18, the Raise and Lower Speed inputs are disabled. The speed reference setting is based on the value of current in the remote speed reference input. When the contacts to terminal 21 are open and the Run/Stop switch is toggled, the Raise Speed and Lower Speed inputs are enabled. The remote speed reference is a 4–20 mA input. The remote speed reference range is tailored in menu 3.

A remote reference of less than 2 mA is considered failed, and the control will remain at the last speed setting. To return to rated speed, the remote switch must be open and the Run/Stop switch toggled.

Diagnostics Request

The Diagnostics Request contact connects to terminal 22 and is used during factory testing of the control. This terminal should be left open during installation.

Run/Stop Fuel Contact

The Run/Stop contact (terminal 23) is the preferred means for a normal shutdown of the engine. The control will not operate without voltage applied to terminal 23. When the contact is closed, the voltage applied to terminal 23 allows the control to move the actuator as required for operating conditions.



WARNING

The Run/Stop contact is not intended for use in any emergency stop sequence. To prevent possible serious injury from an overspeeding engine, do NOT use the Run/Stop contact as part of any emergency stop sequence.

Speed Signal Input

Connect a magnetic pickup (MPU) to terminals 10 and 11 using shielded wire. Connect the shield to the chassis only. Do not connect the shield at the MPU end. Make sure the shield has continuity the entire distance to the speed sensor, and make sure the shield is insulated from all other conducting surfaces.

We recommend that the MPU be dedicated to the control. The MPU output should be from 1 to 60 Vrms.

The Number of Gear Teeth is the number of teeth which will be exposed to the speed sensing device during one revolution of the engine. Should the sensed gear not rotate at engine speed, the number of teeth must be adjusted to reflect the proportion of engine speed to the sensed gear speed. The Number of Gear Teeth is tuned (entered) in Configuration Menu (Menu 6).



WARNING

The Number of Gear Teeth is used by the control to convert pulses from the speed-sensing device to engine rpm. To prevent possible serious injury from an overspeeding engine, make sure the control is properly programmed to convert the gear-tooth count into engine rpm. Improper conversion could cause engine overspeed.

Remote Speed Setting Input

Connect the 4 to 20 mA current transmitter or 1 to 5 Vdc voltage transmitter to terminals 14 (+) and 15 (-). Use a shielded, twisted-pair cable. Connect the shield to the control chassis only.

Aux Voltage Input

Connect the output of a Woodward Load Sensor (if used) to terminals 12 (+) and 13 (-). Use a shielded twisted-pair cable. Wire the remainder of the load sensor in accordance with the wiring diagram for the sensor used.

Control Outputs

Actuator Control

The actuator is connected to terminals 1 (+) and 2 (-). The polarity of this connection must be correct if the actuator is to respond in the desired rotational direction. The actuator cannot be reversed by changing the polarity because of the factory-installed return spring. Use 4 mm² (12 AWG) wire to the actuator. The total length of the pairs of wires between the actuator and the control and between the battery and the control should not exceed 23 m (75 ft).

Speed Switches

Terminals 3, 4, and 5 provide the outputs from speed switches A, B, and C. These outputs close a circuit to the power supply (+). The speed switches are rated to 500 mA. The output will operate a signal lamp directly, or may be connected to an intermediate relay to conduct heavier switch operations. The switch is a low side switch which connects the device attached to the switch to ground. The total length of the wire between the speed switches and the signal lamp or relay should not exceed 8 m (26 ft).

The switches are configured in Menu 3 and operate as shown in Figure 3-7.

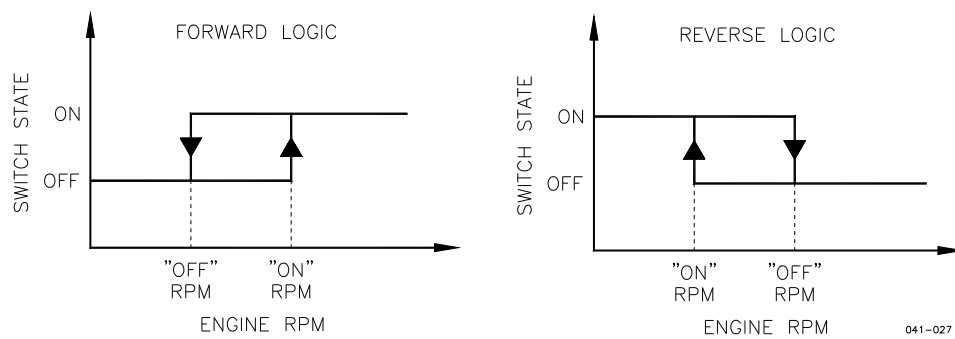

Figure 3-7. Speed Switch Operation

Fault Lamp

Terminal 6 provides the output for the fault lamp indicator. This output closes a circuit to the power supply (+) and is rated for 500 mA to indicate a fault. The output will operate a signal lamp directly, or may be connected to an intermediate relay to conduct heavier switch operations. The faults indicated are actuator position feedback out of range ($0.5 \text{ Vdc} < V_{\text{position}} < 4.5 \text{ Vdc}$), actuator driver circuit open, or actuator overcurrent. The total length of the wire between the speed switches and the signal lamp or relay should not exceed 8 m (26 ft).

Actuator Position Feedback

Shielded wire must be connected to the Actuator Position Feedback terminals 7, 8, and 9. The shield must be continuous and grounded at the control end only to prevent interference with the position feedback signal.

Installation Checkout Procedure

With the installation complete as described in this chapter, do the following check out procedure before beginning the start-up adjustments in Chapter 4.

1. Visual inspection
 - A. Check the linkage or coupling between the actuator and fuel metering device for looseness or binding.
 - B. Check for correct wiring in accordance with the wiring diagram (Figure 1-5).
 - C. Check for broken terminals and loose terminal screws.
 - D. Check the speed sensor for visible damage. If the sensor is a magnetic pickup, check the clearance between the gear and the sensor, and adjust if necessary. Clearance should be between 0.25 and 1.25 mm (0.010 and 0.050 inch) at the closest point. Make sure the gear runout does not exceed the pickup clearance.

2. Check for grounds

Check for grounds by measuring the resistance from all control terminals to chassis. All terminals except terminals 9, 11, and 25, should measure infinite resistance (the resistance of terminals 9 and 11 depends on whether a floating or grounded power source is used). If a resistance less than infinite is obtained, remove the connections from each terminal one at a time until the resistance is infinite. Check the line that was removed last to locate the fault.

3. Stroking the actuator

The actuator may be stroked electronically using the failsafe override in Menu 6 and the start fuel limiter in Menu 4.

IMPORTANT

Do not crank or attempt to start the engine during this procedure.

- A. Verify the Run/Stop contact is open or in the stop mode.
- B. Set the Start Fuel Limiter (Menu 4) to 50% to 90%.
- C. Go to Menu 6 and enter Configuration Key (49). Step down to the Failsafe function and disable it.
- D. Close the Run/Stop contact to run mode.
- E. Go to Start Fuel Limiter (Menu 4) and move the set point up or down. Verify the actuator follows.
- F. Open the Run/Stop contact. Verify the actuator goes to the minimum fuel position (forward acting).

4. Chassis Ground

Check for resistance from chassis to earth ground. The resistance should be zero. If earth ground is not available, tie the chassis to system ground, battery positive or negative.

5. Go to Menu 6, enter Configuration Key (49), and enable the Failsafe switch.

WARNING

To prevent possible serious injury from an overspeeding engine, it is important to have the Failsafe switch enabled prior to cranking the engine.

Chapter 4. Operation and Adjustment

Introduction

Because of the variety of installations, plus system and component tolerances, the control must be tuned to each system for optimum performance.

This chapter contains information on control calibration. It includes initial prestart-up and start-up settings and adjustments.



An improperly calibrated control could cause an engine overspeed or other damage to the engine. To prevent possible serious injury from an overspeeding engine, read this entire procedure before starting the engine.

Using the Hand Held Programmer

The Hand Held Programmer (Figure 4-1) is a hand-held terminal, powered by the ProAct™ Digital Speed Control. The terminal connects to the RS-422 D connector port on the control. Firmly seat the connector on the terminal into J1. Control boxes are equipped with a cover which must be removed to access the J1 receptacle and the two other terminal strips.

When power is applied to the terminal by plugging it into the control, it performs a power-up self-test. Upon successful completion of the self-test, the screen will remain blank. Press the ID key to display the part number and revision level of the software in the control. Refer to this number and revision level in any correspondence with Woodward.

The programmer screen is a four line, back-lighted LCD display. The display permits the user to look at two separate functions or menu items at the same time. Use the “up/down arrow” key to toggle between the two displayed items. The first letter of the active menu will blink.

Changes recorded in the menus may be lost should the ProAct control be powered down. Push the SAVE key to permanently record changes before leaving a menu.

Only the keys listed above are used. Other keys are not used.

Key Function

left arrow	Steps backward through the selected menu.
right arrow	Steps forward through the selected menu.
up/down arrow	Toggles between the upper two-line menu display and the lower two-line menu display.
up arrow	NOT USED.
down arrow	NOT USED.
turtle up	Increases the displayed set point slowly.
turtle down	Decreases the displayed set point slowly.
rabbit up	Increases the displayed set point rapidly.
rabbit down	Decreases the displayed set point rapidly.
1,2,3,4,5,6,0	Accesses Menus 1, 2, 3, 4, 5, 6, or 0. (Number keys are NOT used to change displayed values.)
7,8,9	NOT USED.
-	Removes an inactive menu from the display screen. (This is the only function of the minus key.)
+	NOT USED.
black square	Clears the error log from the programmer.
ID	Displays the software part number and revision. Use this information when contacting Woodward or an authorized service facility.
=	NOT USED.
•	NOT USED.
ESC	NOT USED.
SAVE	Permanently saves changes made to a menu. Changes are NOT saved until the SAVE key is pressed. If the control is powered off before pressing SAVE, the entries will revert back to their previously saved values.
BKSP	NOT USED.
SPACE	NOT USED.
ENTER	NOT USED.

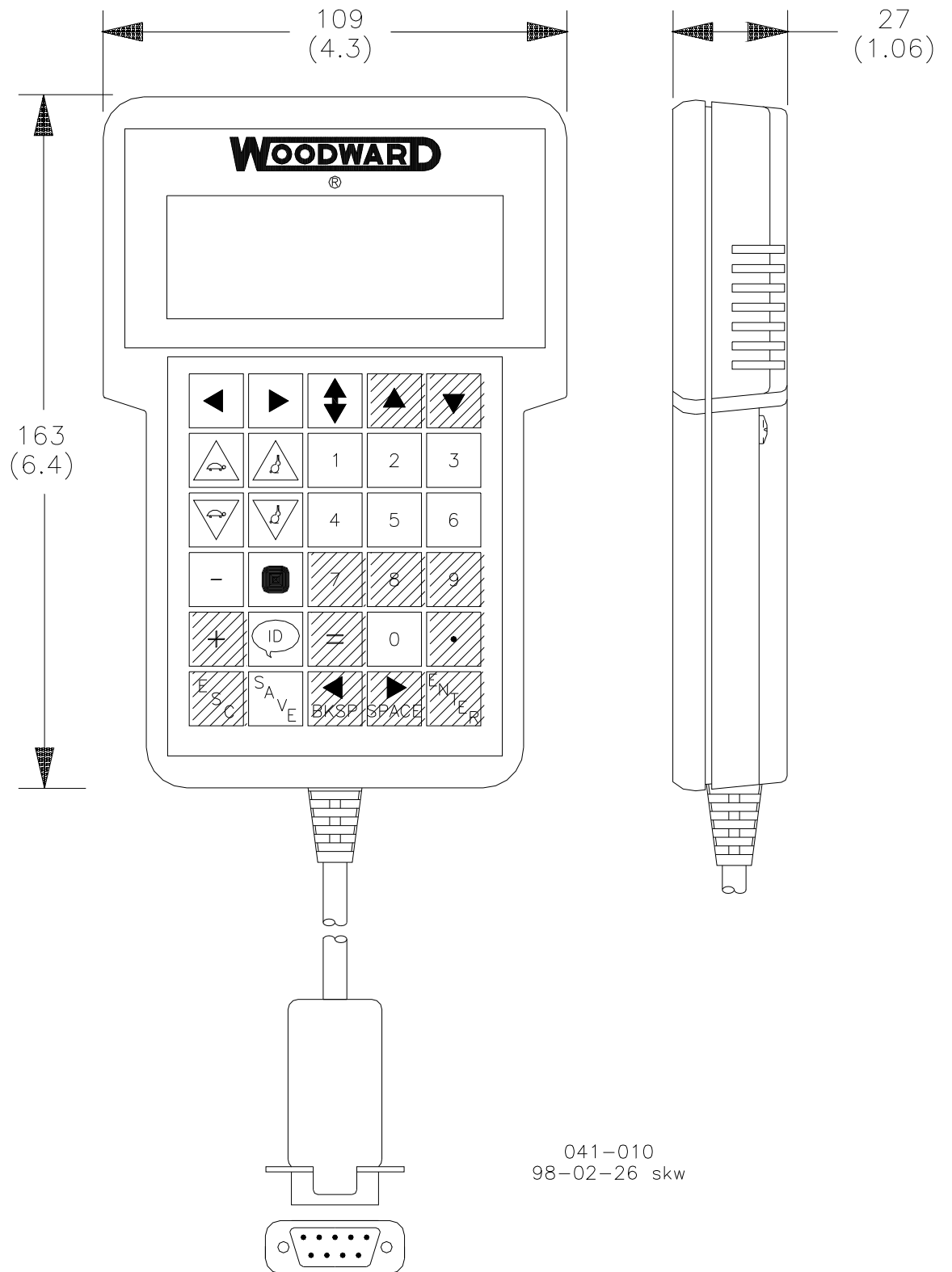

041-010
98-02-26 skw

The Programmer comes with a 54 inch long connecting cable and a "D" connector.

Figure 4-1. Hand Held Programmer (9907-205)

ProAct Control Menus

Menu 1—Dynamics Settings

Menu Item	Low Value	Default Value	High Value	Units
Gain A	0.0003	0.25	10.00	NA
Gain A BP	0.00	0	100.00	%
Gain B	0.0003	0.25	10.00	NA
Gain B BP	0.00	30	100.00	%
Gain C	0.0003	0.25	10.00	NA
Gain C BP	0.00	60	100.00	%
Gain D	0.0003	0.25	10.00	NA
Gain D BP	0.00	100	100.00	%
Stability	0.00	0.25	10.00	seconds
Compensation	0.00	0.10	10.00	seconds
Gain Ratio	1.00	1.00	50.00	NA
Window Width	0.00	60	2000.00	rpm

Menu 2—Alternate Dynamics Settings

Menu Item	Low Value	Default Value	High Value	Units
Alt Gain A	0.0003	0.10	10.00	NA
Alt Gain A BP	0.00	0	100.00	%
Alt Gain B	0.0003	0.10	10.00	NA
Alt Gain B BP	0.00	30	100.00	%
Alt Gain C	0.0003	0.10	10.00	NA
Alt Gain C BP	0.00	60	100.00	%
Alt Gain D	0.0003	0.10	10.00	NA
Alt Gain D BP	0.00	100	100.00	%
Alt Stability	0.00	1.0	10.00	seconds
Alt Compensation	0.00	0.20	10.00	seconds
Alt Gain Ratio	1.00	1	50.00	NA
Alt Window Width	0.00	60	2000.00	rpm

Menu 3—Speed Reference Settings

Menu Item	Low Value	Default Value	High Value	Units
Rated Speed	0	1800	2100	rpm
Idle Speed	0	1200	2100	rpm
Raise Limit	0	1890	2100	rpm
Lower Limit	0	1200	2100	rpm
Accel Time	0	8	500	seconds
Decel Time	0	8	500	seconds
Raise Rate	0	2500	9999	rpm/minute
Lower Rate	0	2500	9999	rpm/minute
20 mA Remote Ref.	0	1890	2100	rpm
4 mA Remote Ref.	0	1710	2100	rpm
Droop	0	5%	100	%
Idle Droop	0	0	100	%
Idle Droop BP	0	0	100	%
Speed Switch A On	0	600	2100	rpm
Speed Switch A Off	0	540	2100	rpm
Speed Switch B On	0	1200	2100	rpm
Speed Switch B Off	0	1140	2100	rpm
Speed Switch C On	0	2000	2100	rpm
Speed Switch C Off	0	1900	2100	rpm

Menu 4—Limiter Settings

Menu Item	Low Value	Default Value	High Value	Units
Max Fuel Limit	0	100	100	%
Transient Over Fuel	0	0	100	%
Transient Time	0	0	10	seconds
Start Fuel Limit	0	40	100	%
Start Ramp Rate	0	1	20	%/second
Start Speed	0	400	1200	rpm
Min Torque Limit	0	50	100	%
Torque Limit BP	0	1500	2100	rpm
Torque Limit at BP	0	70	100	%
Max Torque Limit	0	90	100	%

Menu 5—Monitor Menu

Speed	rpm
Speed Reference	rpm
Actuator Output	%
Aux Input	volts
Remote Input	mA
Run/Stop Switch	Open/Closed
Idle Rated Switch	Open/Closed
Raise Switch	Open/Closed
Lower Switch	Open/Closed
Alternate Dynamics Switch	Open/Closed
Remote Reference Switch	Open/Closed
Isoch Switch	Open/Closed
Diagnostic Switch	Open/Closed
Speed Switch A	On/Off
Speed Switch B	On/Off
Speed Switch C	On/Off
Fault Lamp	On/Off

Menu 6—Configuration Set Points

Menu Item	Low Value	Default Value	High Value	Units
Configuration Key	0	0	100	NA
Number of Gear Teeth	4	60	500	NA
Dynamics Map	Linear	Linear	Nonlinear	NA
Failsafe Function	Disabled	Enabled	Enabled	NA

*—Must be set at "49" before any changes can be made. Engine must be at 0 rpm and the Run/Stop at OPEN to make any changes in this menu.



WARNING

The Failsafe Function must be enabled during normal engine operation to prevent possible overspeed should the MPU signal be lost for any reason. As soon as the control senses engine speed, the failsafe becomes enabled. The function can be overridden to allow some slow cranking engines to start, and to test parts of the governor system without running the engine. Failure to enable the Failsafe Function could allow overspeed with resulting damage to equipment and possible personal injury or death.

Menu 0—Error Menu

Menu Item	Default	Units
Active Errors	None	N/A
Logged Errors	None	N/A
Self Test Result	49*	N/A

*—The correct result is 49. Contact Woodward if the result is not 49.

Configuration, Menu 6, may be viewed at anytime. However, the engine must be shut down and the entry code must be increased from "0" to "49" before changes can be made to Menu 6.

NOTICE

To prevent possible damage to the engine resulting from improper control settings, make sure you **SAVE** the set points before removing power from the control. Failure to **SAVE** the set points before removing power from the control causes them to revert to the previously saved settings.

Description of Menu Set Points

Menu 1—Dynamics Settings

The four Gain set points and break points determine the actuator response to a change in speed or load. These settings can vary as a percent of existing load in nonlinear fuel systems. The adjustments are settings that affect the stability and transient performance of the engine. A large number will provide a faster response to an error between actual speed and reference speed. A small number will provide a slower response to an observed error in speed.

Gain becomes an important portion of the programming that determines the response and stability of an engine.

The control provides two sets of dynamics. Menu 1 sets the primary (normal) dynamics. Menu 2 provides a second set of dynamics for use with an alternate fuel or other conditions which require different control factors.

The set of dynamics being used is selected by the Alternate Dynamics contact input (open for normal dynamics and closed for alternate dynamics).

The following descriptions apply to either set of dynamics. See Figures 4-1 through 4-4.

The four Gain and Gain Breakpoint settings in Menus 1 and 2 provide different response scales to changes in load or speed depending on the existing actuator position. This allows the ProAct control to be programmed to provide a response scale that matches the engine response over the no load to full load range.

RESULTS – GAIN AND STABILITY ADJUSTMENTS

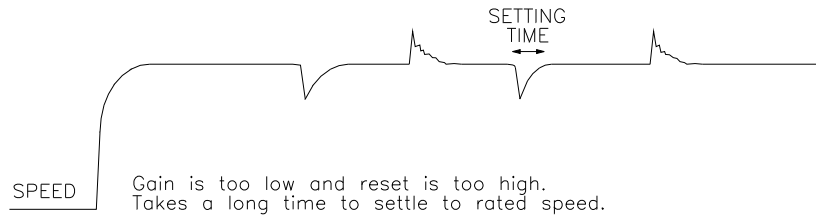
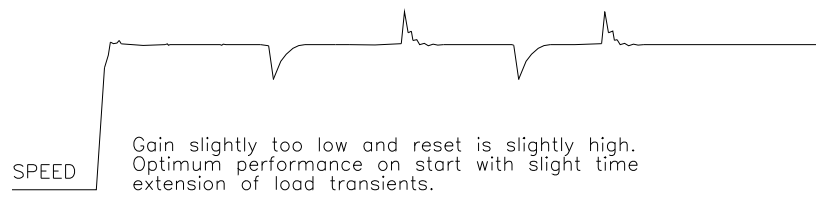
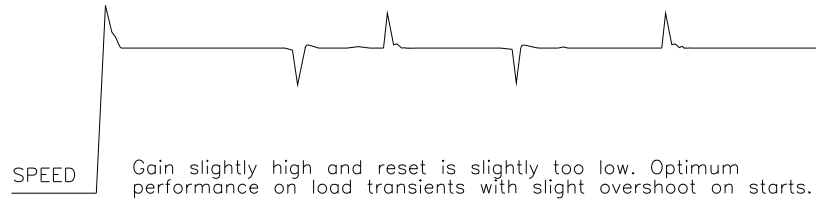
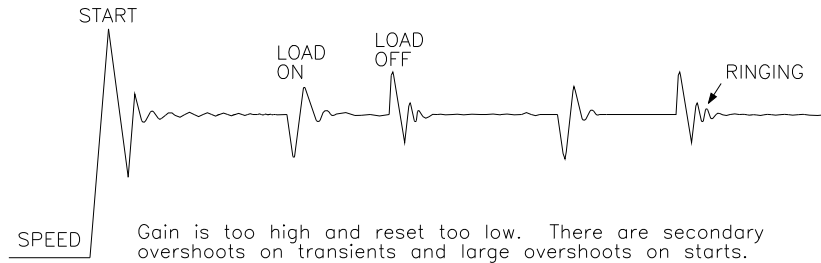

IDEAL LOAD STEP RESPONSE

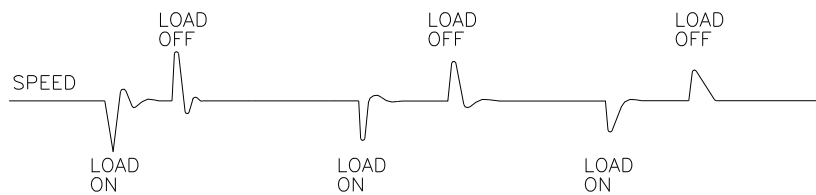

RESULTS – COMPENSATION ADJUSTMENT

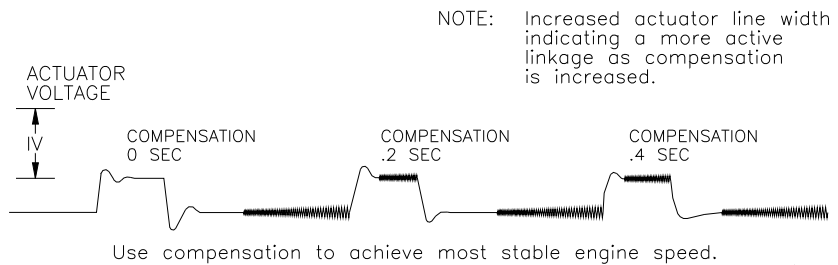

851-004

Figure 4-2. Typical Transient Response Curves

Gas Engine Setup

Change in the butterfly valve position is not linear in comparison to engine power output. In naturally-aspirated (non-turbocharged) engines, the position of the valve in comparison to engine output appears on a chart similar to Figure 4-2.

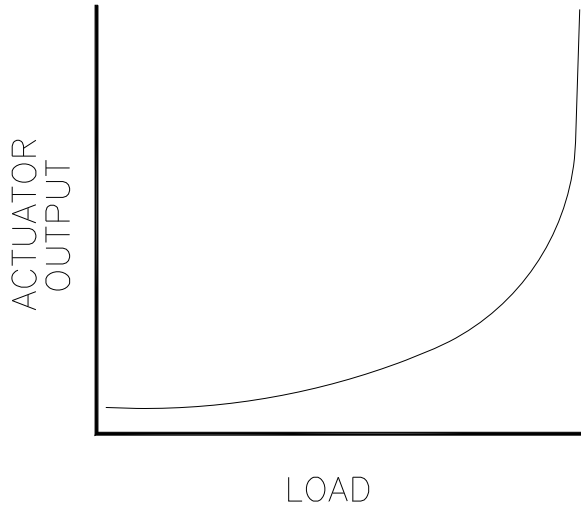

041-090
93-4-8 RAM

Figure 4-3. Non-linear Valve Power Curve

Turbocharged engines distort this curve, particularly as turbo pressure builds to the point of operating the waste gate. A turbocharged gas engine will likely have a butterfly position chart similar to Figure 4-4.

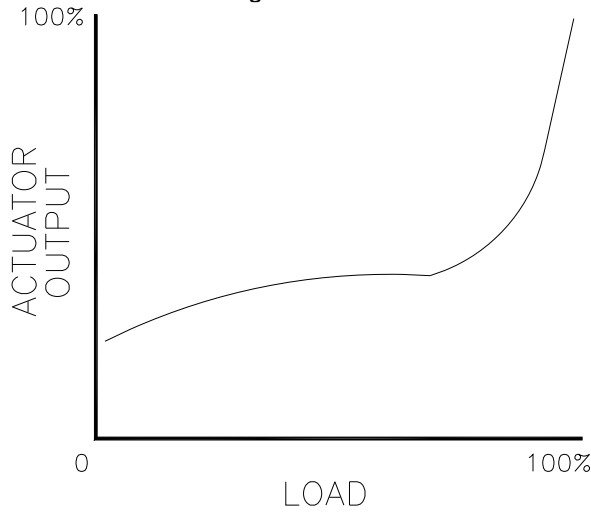

041-090A
00-05-16

Figure 4-4. Sample Engine Plot

Note in both charts that valve position falls on a curve. The ProAct menu does not permit the construction of a curve. However, with four slope segments available, a rough approximation of the curve can be created (see Figure 4-5).

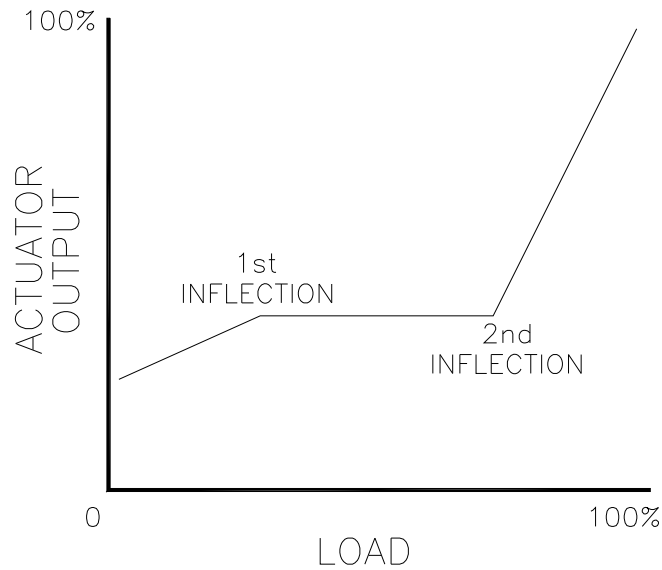

041-090B
00-05-16

Figure 4-5. Linearized Engine Plot

Diesel Engine Setup

Most Diesel engine fuel controls are nearly linear. The dynamics maps may still be used to accommodate nonlinear conditions caused either by the fuel system or by linkage between the actuator and the rack. For gain settings that are not used, set the associated Breakpoint at 100%.

Control Gain Programming Steps

1. Gain programming is needed whenever the gain of the engine and fuel system is non-linear. This usually occurs in gas engine applications. A plot of the fuel system must be determined to properly adjust the gain of the control to match the gain of the system at all loads.

The plot reflects the actuator output, as seen in Menu 5, versus the engine load as load is varied from no load to full load.

To construct a gain plot:

- a. Set the Gain A breakpoint for 100%. This ensures that there won't be any confusion with other settings while plotting the system characteristics. Only Gain A, Stability, and Actuator Compensation will be used.
- b. Start the engine and obtain good control at no load using Gain A, Stability, and Actuator Compensation. Record these settings and the actuator output as displayed in Menu 5.

- c. Step load the engine with as many load steps as are practical. At each load step, Gain A may need to be varied to maintain engine stability. Do not change stability or actuator compensation after the first setting in step b. Should it be necessary to change these settings to obtain good control, repeat all previous steps until only Gain is changed at each load step. At each load step, record the actuator output that is displayed in Menu 5. Also record the engine load and Gain A at each point.

The table on the next page aids in collecting the data for the Gain Plot.

Gain settings reflect the amount of slope as shown in Figure 4-4. Flat portions of the engine plot will require relatively small amounts of gain, steep portions of the plot will require larger gain numbers.

- d. Create a plot of the system by plotting actuator output as a function of load. A typical result is shown in Figure 4-4.

The following table may help in the construction of the plot. Use as many load steps as possible.

Load Step	Gain (for good control)	Actuator Output
Load Step 1		
Load Step 2		
Load Step 3		
Load Step 4		
Load Step 5		
Load Step 6		
Load Step 7		
Load Step 8		
Load Step 9		
Load Step 10		
Load Step 11		
Load Step 12		
Load Step 13		
Load Step 14		
Load Step 15		
Load Step 16		
Load Step 17		
Load Step 18		
Load Step 19		
Load Step 20		

2. Set Gain A to the value recorded in Step 1b. This should give good control at no load.
3. Use the plot of the engine to determine the linearity of the fuel system. This curve should be linearized between inflection points as shown in Figure 4-5.
4. Set the Gain A Breakpoint for the actuator output at or slightly below the value at the first inflection point. The gain of the electronics is constant for actuator outputs less than the Gain A Breakpoint.
5. Set the Gain B Breakpoint at the point slightly above the first inflection point in the actuator output versus load plot.
6. Gain B should now be adjusted to obtain good control at the inflection point. Note: you may already have obtained the correct value in Step 1c.
7. Set the Gain C Breakpoint slightly below the next inflection point in the curve obtained in 1d.
8. Gain C should now be adjusted to obtain best control at this point. Note: the correct value for Gain C may already have been obtained in Step 1c for this load.
9. Gain D breakpoint is normally higher than the second inflection point. The gain of the control is constant after this point.
10. Gain D is adjusted for the best response at full load. This value may also have been determined in Step 1c.

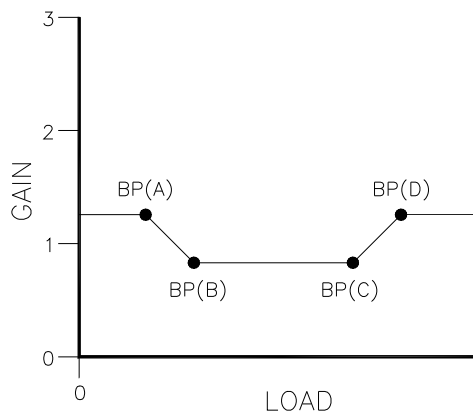

Figure 4-6. Example of Plot Created from GAIN Column

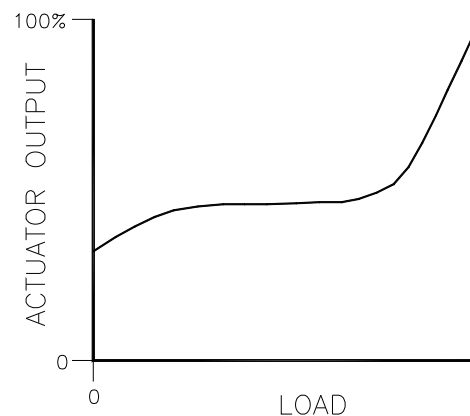

Figure 4-7. Example of Plot Created from ACTUATOR OUTPUT Column

Stability, Actuator Compensation, Gain Ratio, Window Width

11. Stability (also known as Reset) compensates for the lag time of the engine. It adjusts the time required for the control to return the speed to zero error after a disturbance. Stability is adjusted to prevent slow hunting and to minimize speed overshoot after a load disturbance.
12. Compensation compensates for the actuator and fuel system time constant.
13. Gain Ratio operates in conjunction with the Window Width and Gain adjustments by multiplying the Gain set point by the Gain Ratio when the speed error is greater than the Window Width. This makes the control dynamics fast enough to minimize engine speed overshoot on start-up and to reduce the magnitude of speed error when loads are changing. This allows a lower gain at steady state for better stability and reduced steady-state actuator movement.
14. Window Width is the magnitude (in \pm rpm) of a speed error at which the control automatically switches to fast response. The control does not use the absolute value of speed error, but an “anticipated” speed error, to make this switch. This method provides for quick switching to the high gain value when an off speed occurs, and early switching to the low gain value when recovering from the speed transient. This provides smoother switching than if the absolute speed error were used for the window.

Menu 2—Alternate Dynamics Settings

Menu 2 should be programmed similar to Menu 1, but with the alternate fuel or other operating condition expected. The four Gain settings and breakpoints may be set like those used in Menu 1. The Stability, Compensation, Gain Ratio, and Gain Window will probably be quite different if different fuels are being used.

If the engine will not use the alternate operating condition, the menu will not have to be programmed or it can be programmed identically with the Menu 1 to prevent unintentional changes in the dynamics program.

Load Step	Gain (for good control)	Actuator Output
Load Step 1		
Load Step 2		
Load Step 3		
Load Step 4		
Load Step 5		
Load Step 6		
Load Step 7		
Load Step 8		
Load Step 9		
Load Step 10		
Load Step 11		
Load Step 12		
Load Step 13		
Load Step 14		
Load Step 15		
Load Step 16		
Load Step 17		
Load Step 18		
Load Step 19		
Load Step 20		

Menu 3—Speed Reference Settings

Speed adjustments are the settings that affect the speed reference. Descriptions of each menu item follow.

1. Rated Speed Reference sets the normal operating speed of the engine in rpm.
2. Idle Speed Reference sets the speed in rpm at which the engine is operated at start-up. It sometimes is used during cool down.
3. Raise Limit is the maximum speed reference setting in rpm. It is used to limit the Raise Speed command and Remote Reference to a maximum. It normally is set at the maximum rated engine speed.
4. Lower Limit is the minimum speed reference setting in rpm. It is used to limit the Lower Speed command and Remote Reference. It normally is set at the minimum operating speed of the engine.
5. Accel Time is the time required for the control to ramp the engine speed from idle speed to rated speed. The time is set from 0 to 500 seconds. The ramp is started whenever the Idle/Rated switch is closed.

6. Decel Time is the time required for the control to ramp the engine speed from rated speed to idle speed. The time is set from 0 to 500 seconds. The ramp is started whenever the Idle/Rated switch is opened.

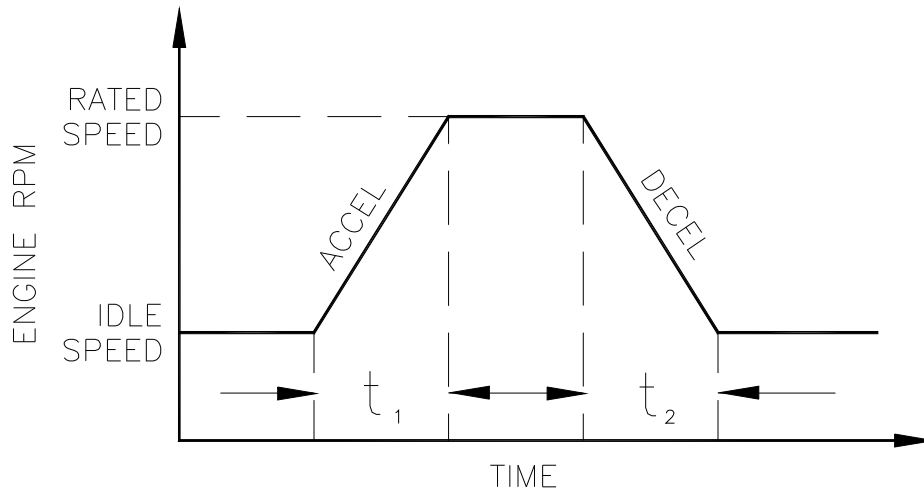

$t = \text{IDLE/RATED RAMP TIME (SECONDS)}$

$t_1 = \text{Accel Time}$ $t_2 = \text{Decel Time}$

041-023
93-3-25 RAM

Figure 4-8. Accel/Decel Example

IMPORTANT

Actual engine deceleration may be slower than set by the Decel Time set point. This occurs when the Decel Time set point is faster than system inertias will allow the engine to slow down in speed. This condition is indicated by the control actuator output going to the minimum fuel position. See Idle Droop below.

7. Raise Rate is the rate at which the speed reference is ramped when using the Raise command or when the Remote Speed Setting input is changed in the increase direction. The rate programmed is in rpm per minute. A step change in the remote input does not cause an immediate change in the reference, which is ramped to the new setting at the Raise Rate.
8. Lower Rate is the rate at which the speed reference is ramped when using the Lower Speed command or when the Remote Speed Setting input is changed in the decrease direction. The rate is set in rpm per minute. A step change in the remote input does not cause an immediate change in the reference, which is ramped to the new setting at the Lower Rate.
9. 20 mA Remote Reference is the engine speed desired when 20 mA is applied to the Remote Speed Reference input. The desired speed is set in rpm.
10. 4 mA Remote Reference is the engine speed desired when 4 mA is applied to the Remote Speed Reference input. The desired speed is set in rpm.

11. Droop is set as the percent rated speed will be decreased from no load to full load. Droop will be included in the engine control schedule only when the Isoch/Droop contact is open.

The percentage of Droop entered is based on 75° of actuator travel. If less than full travel is used, the droop percentage must be increased proportionally.

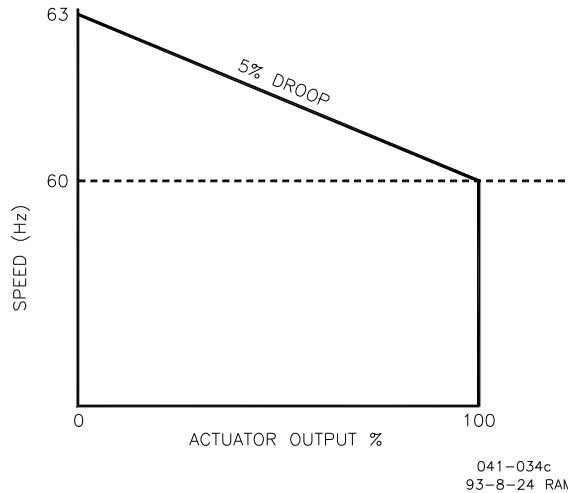

Figure 4-9. Droop Curve

12. Idle Droop combined with the Idle Droop Breakpoint is used to limit speed undershoot when large decel rates are used from rated to idle.

Idle Droop is based on the actuator output when it drops below the Idle Droop Breakpoint setting. Dependencies on linkage make the Idle Droop percentage relative, so large droop settings may be required to achieve the desired results.
13. Idle Droop Breakpoint is normally set equal to the actuator output obtained when the engine is unloaded and at low idle. When the output of the control drops below this setting or goes to minimum fuel during rapid engine deceleration, Idle Droop will raise the speed reference. This brings the engine back under control sooner and reduces speed undershoot. Speed undershoot may occur because the time required for the control to return to the new fuel setting is dependent on control dynamics and linkage adjustment.
14. Speed Switch A ON sets the rpm that will turn on Speed Switch A.
15. Speed Switch A OFF sets the rpm that will turn off Speed Switch A.
16. Speed Switch B ON sets the rpm that will turn on Speed Switch B.
17. Speed Switch B OFF sets the rpm that will turn off Speed Switch B.
18. Speed Switch C ON sets the rpm that will turn on Speed Switch C.

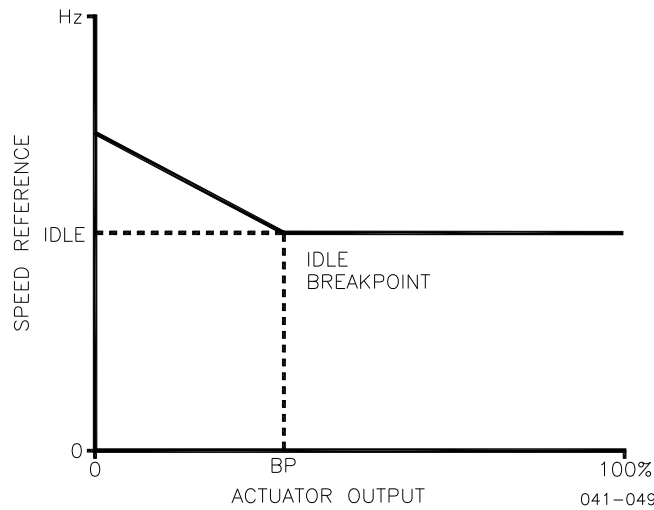

Figure 4-10. Idle Droop

19. Speed Switch C OFF sets the rpm that will turn off Speed Switch C.

The speed switch changes state at the selected speed position. Each switch allows 500 mA to sink to the negative of the power supply when closed.

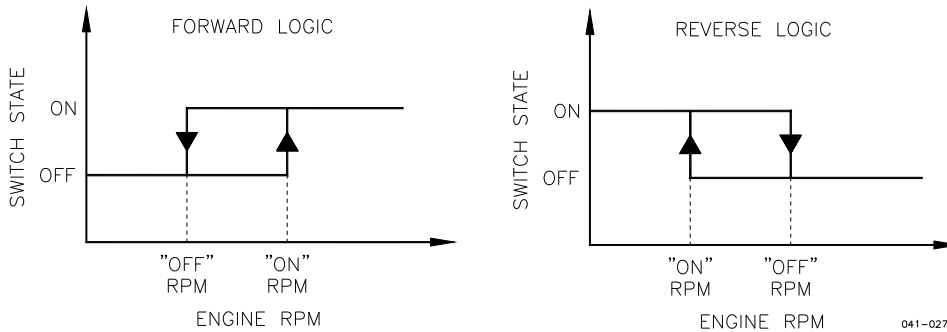

Figure 4-11. Speed Switch Settings

Menu 4—Limiter Settings

Fuel limiters limit the actuator output from the control. Descriptions of each menu item follow.

1. Maximum Fuel Limit sets the maximum percent actuator output when rated speed is selected. If the actuator linkage is correctly set so the actuator is providing the maximum position stop, 3° in advance of the butterfly valve maximum position, this item may be set at 100%. If the actuator must reach maximum before it reaches its maximum stop, the entry must be below 100%.

NOTICE

Damage to the butterfly valve and possible jamming of the valve in the wide open position is possible if linkage is not designed to reach maximum actuator position at least 3° in advance of maximum butterfly valve position.

The Maximum limit may be used to limit the horsepower developed in the engine.

2. Transient Limit is used when the maximum fuel limit is controlling the output horsepower of the engine. The transient limit allows overfueling of the engine by the amount tuned into the control. This allows the engine to accelerate to the rated load.
3. Transient Time is the amount of time that the Transient Limit is allowed to operate.
4. Start Fuel Limit is a limit that is in place while the engine is starting. This limit helps reduce smoke on diesel engines and prevents overfueling during the start of gas engines. The limit is removed when the engine reaches Start Speed.
5. Start Ramp is a tunable ramp of the actuator output to ensure starting of cold engines. The control ramps the position of the actuator from the Start Fuel Limit open at a controlled rate until the engine starts. After the engine has started, the fuel limits will be set by the Maximum Fuel Limit or the Torque Limit, whichever is less.
6. Start Speed sets the speed in rpm that will remove the start-fuel limit from the control system. When Start Speed is obtained, the speed ramps to idle or rated speed, depending on the selection made. After start speed is attained, the control uses the Maximum Fuel and Torque limits.
7. Minimum Torque Limit is the percent actuator output allowed when the engine speed is at or below the Lower Limit speed setting (Menu 3). The torque limiter provides a value between Minimum Torque Limit and Breakpoint Torque Limit when engine speed is between these two settings. This sets the torque limit slope below the Breakpoint position.
8. Torque Limit Breakpoint (BP) is the engine speed at which the slope of the torque limiter output changes. The Torque Limit Breakpoint must be set between the Raise and Lower Limits described under Menu 3.
9. (BP) Torque Limit at Breakpoint (BP) is the percent actuator output at the engine speed set by the Torque Limit Breakpoint described above.
10. Maximum Torque Limit is the maximum percent actuator output when the engine speed is at the Raise Limit speed setting. The torque limiter provides a value between the Breakpoint Torque Limit and Maximum Torque Limit when engine speed is between these two settings. This sets the slope above the torque limit breakpoint setting.

Figure 4-12 illustrates the breakpoint and these adjustments.

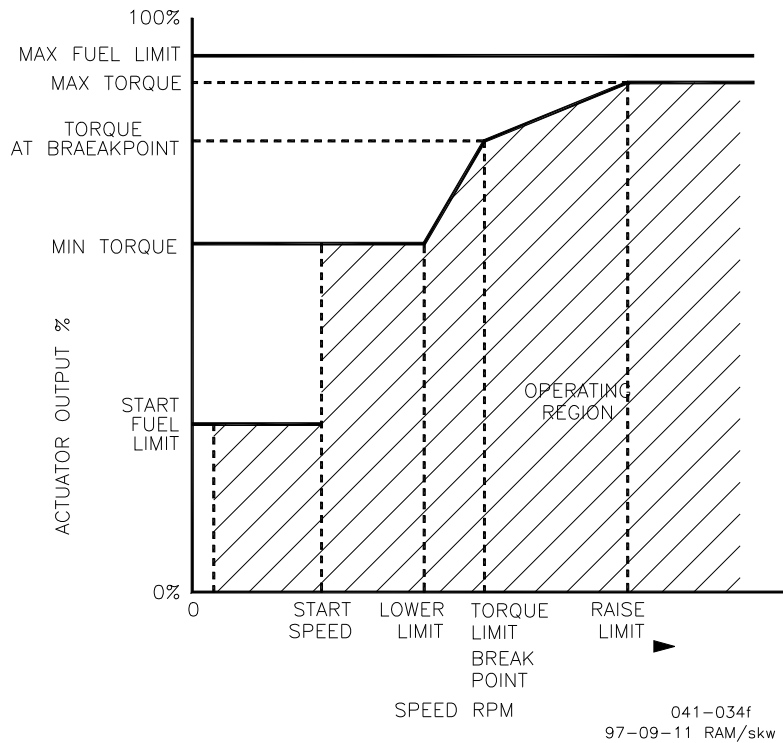

Figure 4-12. Torque Limit Map

Menu 5—Monitor Menu

Input or output values displayed on the hand held are continuously updated. Descriptions of each menu item follow:

1. Speed displays the current engine speed in rpm.
2. Speed Reference displays the current speed reference in rpm. Note that this may not be the current speed of the engine due to the effect of idle droop, fuel limiters, auxiliary input, or droop.
3. Actuator Output displays the current percent of Actuator output. This is useful for setup of the control fuel limiters, torque limiter, idle droop, and gain breakpoint settings.
4. Aux Input displays the voltage on the Aux Input.
5. Remote Input displays the milliamps on the Remote Speed Setting Input. This is useful for testing and system calibration.
6. Actuator Current provides a readout of the current to the actuator.
7. Actuator Position provides the voltage reading from the position feedback.
8. Run/Stop Switch Status displays the status of the discrete input at terminal 23. Closed indicates 24 Vdc is applied to the input selecting the run position. Open selects minimum fuel or the stop position.

9. Idle/Rated Switch Status displays the status of discrete input at terminal 17. Closed indicates 24 Vdc is applied to the input selecting rated speed and the maximum fuel limit is selected. Open indicates idle speed and the idle fuel limit.
10. Raise Switch Status displays the status of discrete input at terminal 19. Closed indicates 24 Vdc is applied to the input selecting raise speed.
11. Lower Switch Status displays the status of discrete input at terminal 18. Closed indicates 24 Vdc is applied to the input selecting lower speed.
12. Alternate Dynamics Switch Status displays the status of discrete input at terminal 20. Closed indicates 24 Vdc is applied to the input selecting the Alternate Dynamics.
13. Remote Reference Switch Status displays the status of discrete input at terminal 21. Closed enables the remote speed setting at terminals 14 and 15 and disables the Raise and Lower switches.
14. Isoch displays the status of the contacts at terminal 16. Open is droop, closed is in isochronous.
15. Diagnostic indicates the status of the diagnostics switch.
16. Speed Switch A, terminal 3, indicates the on/off position of the switch.
17. Speed Switch B, terminal 4, indicates the on/off position of the switch.
18. Speed Switch C, terminal 5, indicates the on/off position of the switch.
19. Fault Lamp indicates the switch position at terminal 6. This switch is on when a fault has been detected. The system must be turned off and powered back up to extinguish the lamp.

Menu 6—Configuration Set Points

1. Configuration Key is a code which must be entered before you can change any of the set points on the configuration menu. This helps prevent accidental modification of the set points. The code is factory set to “49”. Use the “rabbit” or “turtle” keys to select the code. The code will be returned to “0” when the menu is exited.
2. Number of Gear Teeth is the number of teeth or holes in the gear or flywheel that drives the speed-sensing device. If the gear is running at camshaft speed (one-half engine speed) then you must enter one-half the number of teeth on the gear. The control requires the number of teeth seen by the MPU per engine revolution.

IMPORTANT

Best control performance will be obtained when sensing speed from a gear rotating at full engine speed. Slower-speed gears (such as the camshaft) provide a lower sampling rate which reduces control response time.

! WARNING

The number of gear teeth is used by the control to convert pulses from the speed-sensing device to engine rpm. To prevent possible serious injury from an overspeeding engine, make sure the control is properly programmed to convert the gear-tooth count into engine rpm. Improper conversion could cause engine overspeed.

3. Dynamics Map selects the mapping algorithm used to map dynamics as a function of engine speed. Figure 4-13 illustrates how dynamics vary as a function of engine speed for each map.
4. Failsafe Function. Use Rabbit or Turtle keys: Up to enable, Down to disable.

! WARNING

The Failsafe function causes the ProAct control to issue a minimum fuel signal should the MPU signal fail. Should the function be disabled (to permit a fuel position while cranking or for test procedures), it must be enabled again to prevent overspeed should the signal fail while the engine is operating. Engine overspeed can damage equipment and cause personal injury or death.

Menu 0—Error Menu

1. Active Errors display errors that the control has detected that are still present. The error must be corrected before operation of the engine. Active errors can be cleared by toggling Run/Stop.

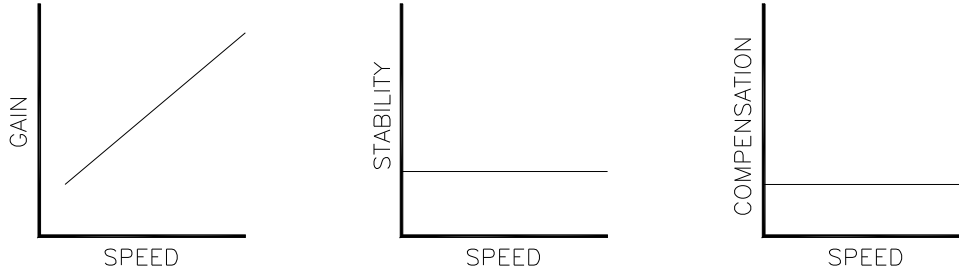

LINEAR DYNAMICS MAP

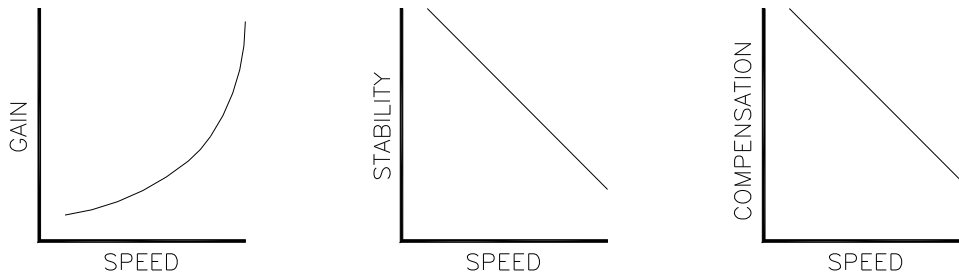

NON-LINEAR DYNAMICS MAP

027-066
97-08-22

Figure 4-13. Dynamics Map Curves

2. Logged Errors provides a means of recording errors that the control detects. The error log will be saved, even if power to the control is lost. To clear the error log, press the “hot” (“black square”) key.
3. Self Test Result displays the result of power up diagnostics performed on the microprocessor, data, and program memory. A successful test gives a result of 49. Contact Woodward if the self test result is not 49.

Conclusion of Test and Calibration Procedures

This completes the calibration instructions. Save the set points by pressing the SAVE key on the Hand Held Programmer. Power down the control for about 10 seconds. Restore power and verify that all set points are as recorded.

NOTICE

To prevent possible damage to the engine resulting from improper control settings, make sure you save the set points before removing power from the control. Failure to save the set points before removing power from the control causes them to revert to the previously saved settings.

Disconnect the Set Point Programmer from the control.

WARNING

Be prepared to make an emergency shutdown when starting the engine, turbine, or other type of prime mover, to protect against runaway or overspeed with possible personal injury, loss of life, or property damage.

Chapter 5. System Troubleshooting Charts

Problem	Cause	Remedy
Prime mover will not start. Actuator not moving to start fuel position.	Supply voltage polarity reversed, or no supply voltage.	Check for supply voltage from terminals 24 (+) to 25 (-). Reverse leads if polarity is incorrect.
<div style="background-color: green; color: white; padding: 2px; font-weight: bold; margin-bottom: 5px;">IMPORTANT</div> If the actuator moves to start position, a problem with the prime mover fuel supply is indicated.	Actuator not responding to input signal from control.	If there is a voltage output at control terminals 1 (+) and 2 (-), but the actuator does not move, check the wiring to the actuator for opens or shorts. Check the polarity of the actuator and feedback. Check actuator and linkage for proper installation and operation. Problems may be direction of rotation, linkage, worn components, or improper adjustment.
	Start fuel limit set too low.	Increase start fuel limit until prime mover starts.
		Increase Start Ramp.
	Speed setting too low on initial start.	Speed setting may be lower than cranking speed. Control should be set for rated speed. Increase Rated Speed setting.
		<div style="background-color: blue; color: white; padding: 2px; font-weight: bold; margin-bottom: 5px;">NOTICE</div> If adjusting Rated Speed does not produce the correct output, return Rated Speed setting to normal start position.
	Idle Speed setting may be set too low.	Adjust idle speed.
Run/Stop contact open.	Check terminal 23. Run/Stop contact must be closed for normal operation. Check monitor menu for switch position.	

Problem	Cause	Remedy
Prime mover will not start. Actuator not moving to start fuel position. (cont.)	Speed sensor signal not clearing failed speed signal circuit.	<p>Check wiring for proper connection. Check shields for proper installation.</p> <p>Speed sensor not spaced properly. Check for at least 1.0 Vac at terminals 10 and 11 during cranking. If less than 1.0 Vac, magnetic pickup may be spaced too far from gear. Make sure there are no metal chips on end of pickup.</p> <p>Check the number of teeth seen by the MPU per engine revolution against the number entered in step 2 of Menu 6.</p> <p>If no voltage is present, magnetic pickup may be open-circuited or shorted. Make resistance check with the leads disconnected from control. Should be 100 to 300 Ω.</p> <p>Check Error Menu 0 for faults.</p> <p>⚠ WARNING</p> <p>The Failed Speed Signal must be enabled for routine operation of the engine to ensure shutdown and prevent possible life threatening overspeed should the MPU signal be lost at some future time.</p> <p>Check Monitor Menu for Speed When Cranking.</p> <p>⚠ WARNING</p> <p>Be prepared to make an emergency shutdown when starting the engine, turbine, or other type of prime mover, to protect against runaway or overspeed with possible personal injury, loss of life, or property damage.</p>
	Faulty ProAct control.	Replace control.

Problem	Cause	Remedy
Prime mover overspeeds only on starts.	Control adjustment.	Control may be adjusted for sluggish operation causing overspeed on start. Slowly adjust GAIN for fastest stable response. Stability may be adjusted too low. Increase Stability setting. Start Fuel Limit may be too high. Start Ramp may be too high. Start speed may be too low. Wrong set of dynamics may have been selected.
	Linkage/Coupling.	On diesel installations verify that fuel rack is not binding and linkage is properly adjusted. It may be necessary to determine if the fuel rack is quickly following the actuator. On carburetor installations check that the butterfly is not binding. Check linkage or coupling adjustment.
	Overspeed Device.	Verify proper operation of overspeed protection devices to determine if a shutdown is occurring without an overspeed condition.
	ProAct control.	If the control does not cut back the actuator output (Menu 5), the ProAct control may be faulty. If the signal is cut back, look for a problem in the linkage or actuator.
Prime mover overspeeds after operating at rated speed for some time.	Prime mover.	Check for proper operation of prime mover fuel system. If actuator moves toward minimum fuel during overspeed, problem may not be connected with the governor.
Speed not regulated (hunting).	Incorrect dynamics programmed in control or incorrect dynamics program selected.	Improve dynamics settings or select correct dynamics program.
Los speed is not regulated at idle speed.	Actuator and linkage.	The Idle Speed setting may be below the minimum-fuel position of the actuator or prime mover fuel stop. In this case, the output voltage to the actuator will be zero. The engine will be maintained at the minimum-fuel position by the actuator or the prime mover minimum-fuel stop. These conditions indicate that the prime mover minimum-fuel position should be decreased by linkage adjustment (diesel engine) or low-idle set screw (gas engine), or the Idle Speed setting should be raised. If this action does not correct the problem, the control may be faulty.
Prime mover does not decelerate when Rated contact is open.	Faulty Rated contact.	Check Idle/Rated contact. Remove wire from terminal 17. Prime mover should decelerate.
	ProAct control ramp circuitry.	A faulty Rated contact may remain in the accelerate position with the contact open. If the Rated contact is operative, loss of idle control may be due to a faulty circuit.

Problem	Cause	Remedy
<p>Prime mover will not stabilize at rated no-load speed. The instability may occur at no load or it may vary with load. Control may be erratic.</p>	<p>ProAct control.</p>	<p>Adjust GAIN, Stability, and ACTUATOR COMPENSATION in Menu 1 or 2. Check Gain Breakpoint for the lower speeds.</p>
	<p>Necessary external wires not properly shielded. (Electrical noise, caused by wiring carrying an ac voltage, stray magnetic fields from transformers, etc., can be picked up by improperly shielded wire. Noise will cause instability if picked up by magnetic pickup, position feedback, auxiliary input, or remote reference lines.)</p>	<p>The following tests will isolate noise and interference.</p> <p>Verify that the switchgear frame, governor chassis, and prime mover have a common ground connection. Temporarily remove the battery-charger cables from the control battery system.</p> <p>If the prime-mover operation is significantly improved by these modifications, replace the wires one at a time to locate the source of the trouble.</p> <p>External wiring may require additional shielding or rerouting from high-current lines or components.</p> <p>If the problem cannot be solved by these checks, it will be necessary to remove the control from the switchgear. Temporarily mount the control next to the prime mover and connect only a battery, magnetic pickup, and actuator to the control (use a separate battery placed next to the prime mover). After starting the prime mover, if necessary, apply load to check stability.</p> <p>If stability occurs when the control is mounted next to the prime mover, return the control to the switchgear. Run new magnetic pickup, actuator feedback, and battery power lines. Shield all wires to the control. Route all wires through conduit or an outer shield. Tie the outer shield to system ground at the end opposite to the control.</p>
	<p>Prime mover may not be receiving fuel as called for by the actuator voltage.</p>	<p>Check actuator linkage to fuel-controlling mechanism for any lost motion, binding, or excessive loading. Verify a steady fuel pressure of proper value.</p>
	<p>Prime mover not operating properly.</p>	<p>Prime mover may be causing speed variations. Control engine manually to determine if instability is in prime mover or governor control. Verify proper adjustment of fuel control linkage.</p>
	<p>Input voltage low.</p>	<p>Check supply voltage. It should be at least 18 Vdc, not more than 32 Vdc.</p>
<p>Prime mover will not accept full load.</p>	<p>Prime mover.</p>	<p>If droop occurs near the full-load point only, it is possible the prime mover is not producing the power called for by the fuel control, or is being overloaded. Either is indicated if the fuel control is at maximum position.</p>
	<p>ProAct control.</p>	<p>Check Max Fuel Limit setting. Increase if required. Check Torque Limiter settings. Increase if required.</p> <p>Check droop setting. Set to 0 if required.</p> <p>Check Aux Input terminals to see if the auxiliaries are out of range. Maximum voltage is 2.5 Vdc.</p> <p>Check linkage from actuator to fuel rack.</p>

Chapter 6.

Service Options

Product Service Options

If you are experiencing problems with the installation, or unsatisfactory performance of a Woodward product, the following options are available:

- Consult the troubleshooting guide in the manual.
- Contact the manufacturer or packager of your system.
- Contact the Woodward Full Service Distributor serving your area.
- Contact Woodward technical assistance (see “How to Contact Woodward” later in this chapter) and discuss your problem. In many cases, your problem can be resolved over the phone. If not, you can select which course of action to pursue based on the available services listed in this chapter.

OEM and Packager Support: Many Woodward controls and control devices are installed into the equipment system and programmed by an Original Equipment Manufacturer (OEM) or Equipment Packager at their factory. In some cases, the programming is password-protected by the OEM or packager, and they are the best source for product service and support. Warranty service for Woodward products shipped with an equipment system should also be handled through the OEM or Packager. Please review your equipment system documentation for details.

Woodward Business Partner Support: Woodward works with and supports a global network of independent business partners whose mission is to serve the users of Woodward controls, as described here:

- A **Full Service Distributor** has the primary responsibility for sales, service, system integration solutions, technical desk support, and aftermarket marketing of standard Woodward products within a specific geographic area and market segment.
- An **Authorized Independent Service Facility (AISF)** provides authorized service that includes repairs, repair parts, and warranty service on Woodward's behalf. Service (not new unit sales) is an AISF's primary mission.
- A **Recognized Engine Retrofitter (RER)** is an independent company that does retrofits and upgrades on reciprocating gas engines and dual-fuel conversions, and can provide the full line of Woodward systems and components for the retrofits and overhauls, emission compliance upgrades, long term service contracts, emergency repairs, etc.
- A **Recognized Turbine Retrofitter (RTR)** is an independent company that does both steam and gas turbine control retrofits and upgrades globally, and can provide the full line of Woodward systems and components for the retrofits and overhauls, long term service contracts, emergency repairs, etc.

A current list of Woodward Business Partners is available at www.woodward.com/support.

Woodward Factory Servicing Options

The following factory options for servicing Woodward products are available through your local Full-Service Distributor or the OEM or Packager of the equipment system, based on the standard Woodward Product and Service Warranty (5-01-1205) that is in effect at the time the product is originally shipped from Woodward or a service is performed:

- Replacement/Exchange (24-hour service)
- Flat Rate Repair
- Flat Rate Remanufacture

Replacement/Exchange: Replacement/Exchange is a premium program designed for the user who is in need of immediate service. It allows you to request and receive a like-new replacement unit in minimum time (usually within 24 hours of the request), providing a suitable unit is available at the time of the request, thereby minimizing costly downtime. This is a flat-rate program and includes the full standard Woodward product warranty (Woodward Product and Service Warranty 5-01-1205).

This option allows you to call your Full-Service Distributor in the event of an unexpected outage, or in advance of a scheduled outage, to request a replacement control unit. If the unit is available at the time of the call, it can usually be shipped out within 24 hours. You replace your field control unit with the like-new replacement and return the field unit to the Full-Service Distributor.

Charges for the Replacement/Exchange service are based on a flat rate plus shipping expenses. You are invoiced the flat rate replacement/exchange charge plus a core charge at the time the replacement unit is shipped. If the core (field unit) is returned within 60 days, a credit for the core charge will be issued.

Flat Rate Repair: Flat Rate Repair is available for the majority of standard products in the field. This program offers you repair service for your products with the advantage of knowing in advance what the cost will be. All repair work carries the standard Woodward service warranty (Woodward Product and Service Warranty 5-01-1205) on replaced parts and labor.

Flat Rate Remanufacture: Flat Rate Remanufacture is very similar to the Flat Rate Repair option with the exception that the unit will be returned to you in “like-new” condition and carry with it the full standard Woodward product warranty (Woodward Product and Service Warranty 5-01-1205). This option is applicable to mechanical products only.

Returning Equipment for Repair

If a control (or any part of an electronic control) is to be returned for repair, please contact your Full-Service Distributor in advance to obtain Return Authorization and shipping instructions.

When shipping the item(s), attach a tag with the following information:

- return number;
- name and location where the control is installed;
- name and phone number of contact person;
- complete Woodward part number(s) and serial number(s);
- description of the problem;
- instructions describing the desired type of repair.

Packing a Control

Use the following materials when returning a complete control:

- protective caps on any connectors;
- antistatic protective bags on all electronic modules;
- packing materials that will not damage the surface of the unit;
- at least 100 mm (4 inches) of tightly packed, industry-approved packing material;
- a packing carton with double walls;
- a strong tape around the outside of the carton for increased strength.

NOTICE

To prevent damage to electronic components caused by improper handling, read and observe the precautions in Woodward manual 82715, *Guide for Handling and Protection of Electronic Controls, Printed Circuit Boards, and Modules*.

Replacement Parts

When ordering replacement parts for controls, include the following information:

- the part number(s) (XXXX-XXXX) that is on the enclosure nameplate;
- the unit serial number, which is also on the nameplate.

Engineering Services

Woodward offers various Engineering Services for our products. For these services, you can contact us by telephone, by email, or through the Woodward website.

- Technical Support
- Product Training
- Field Service

Technical Support is available from your equipment system supplier, your local Full-Service Distributor, or from many of Woodward's worldwide locations, depending upon the product and application. This service can assist you with technical questions or problem solving during the normal business hours of the Woodward location you contact. Emergency assistance is also available during non-business hours by phoning Woodward and stating the urgency of your problem.

Product Training is available as standard classes at many of our worldwide locations. We also offer customized classes, which can be tailored to your needs and can be held at one of our locations or at your site. This training, conducted by experienced personnel, will assure that you will be able to maintain system reliability and availability.

Field Service engineering on-site support is available, depending on the product and location, from many of our worldwide locations or from one of our Full-Service Distributors. The field engineers are experienced both on Woodward products as well as on much of the non-Woodward equipment with which our products interface.

For information on these services, please contact us via telephone, email us, or use our website and reference www.woodward.com/support, and then **Customer Support**.

How to Contact Woodward

For assistance, call one of the following Woodward facilities to obtain the address and phone number of the facility nearest your location where you will be able to get information and service.

Electrical Power Systems		Engine Systems		Turbine Systems	
Facility	Phone Number	Facility	Phone Number	Facility	Phone Number
Australia	+61 (2) 9758 2322	Australia	+61 (2) 9758 2322	Australia	+61 (2) 9758 2322
Brazil	+55 (19) 3708 4800	Brazil	+55 (19) 3708 4800	Brazil	+55 (19) 3708 4800
China	+86 (512) 6762 6727	China	+86 (512) 6762 6727	China	+86 (512) 6762 6727
Germany:		Germany:			
Kempen	+49 (0) 21 52 14 51	Stuttgart	+49 (711) 78954-0		
Stuttgart	+49 (711) 78954-0	Stuttgart	+49 (711) 78954-0		
India	+91 (129) 4097100	India	+91 (129) 4097100	India	+91 (129) 4097100
Japan	+81 (43) 213-2191	Japan	+81 (43) 213-2191	Japan	+81 (43) 213-2191
Korea	+82 (51) 636-7080	Korea	+82 (51) 636-7080	Korea	+82 (51) 636-7080
		The Netherlands	+31 (23) 5661111	The Netherlands	+31 (23) 5661111
Poland	+48 12 618 92 00				
United States	+1 (970) 482-5811	United States	+1 (970) 482-5811	United States	+1 (970) 482-5811

You can also contact the Woodward Customer Service Department or consult our worldwide directory on Woodward's website (www.woodward.com/support) for the name of your nearest Woodward distributor or service facility.

For the most current product support and contact information, please refer to the latest version of publication **51337** at www.woodward.com/publications.

Technical Assistance

If you need to telephone for technical assistance, you will need to provide the following information. Please write it down here before phoning:

General

Your Name _____

Site Location _____

Phone Number _____

Fax Number _____

Prime Mover Information

Engine/Turbine Model Number _____

Manufacturer _____

Number of Cylinders (if applicable) _____

Type of Fuel (gas, gaseous, steam, etc) _____

Rating _____

Application _____

Control/Governor Information

Please list all Woodward governors, actuators, and electronic controls in your system:

Woodward Part Number and Revision Letter

Control Description or Governor Type

Serial Number

Woodward Part Number and Revision Letter

Control Description or Governor Type

Serial Number

Woodward Part Number and Revision Letter

Control Description or Governor Type

Serial Number

If you have an electronic or programmable control, please have the adjustment setting positions or the menu settings written down and with you at the time of the call.

Appendix. Menu Summary

Initial Prestart Settings

These tables are provided for the convenience of the ProAct™ user. Each number should be recorded as it is programmed with the Hand Held Programmer. Any changes should be noted so the adjustment can be referenced from its original setting.

IMPORTANT

Please refer to application note 51317, *ProAct Digital Speed Control System with Start-up Fuel Limiting*, if this is a fuel-limiting version. Menus 3 and 4 have additional settings.

Menu 1—Dynamics Settings

Menu Item	Default Setting	Gas	Diesel	Actual Setting
		Engine Prestart Setting	Engine Prestart Setting	
Gain A	0.25	0.025	0.050	_____
Gain A break point	0%	100%	100%	_____
Gain B	0.25	0.025	0.050	_____
Gain B break point	30%	100%	100%	_____
Gain C	0.25	0.025	0.050	_____
Gain C break point	60%	100%	100%	_____
Gain D	0.25	0.025	0.050	_____
Gain D break point	100%	100%	100%	_____
Stability	0.25 sec.	1.0 sec.	1.0 sec.	_____
Compensation	0.10 sec.	0.15 sec.	0.15 sec.	_____
Gain Ratio	1.00	1	1	_____
Gain Window	60 rpm	60 rpm	60 rpm	_____

Menu 2—Alternate Dynamics Settings

Menu Item	Default Setting	Gas	Diesel	Actual Setting
		Engine Prestart Setting	Engine Prestart Setting	
Alt Gain A	0.10	0.025	0.050	_____
Gain A break point	0%	100%	100%	_____
Alt Gain B	0.10	0.025	0.050	_____
Gain B break point	30%	100%	100%	_____
Alt Gain C	0.10	0.025	0.050	_____
Gain C break point	60%	100%	100%	_____
Alt Gain D	0.10	0.025	0.050	_____
Gain D break point	100%	100%	100%	_____
Alt Stability	1.0 sec.	1.0 sec.	1.0 sec.	_____
Compensation	0.20 sec.	0.15 sec.	0.15 sec.	_____
Alt Gain Ratio	1	1	1	_____
Alt Gain Window	60 rpm	60 rpm	60 rpm	_____

Menu 3—Speed Reference Settings

IMPORTANT

Please refer to application note 51317, *ProAct Digital Speed Control System with Start-up Fuel Limiting*, if this is a fuel-limiting version.

Menu Item	Default Setting	Actual Setting
Rated Speed	1800 rpm	_____
Idle Speed	1200 rpm	_____
Raise Limit	1890 rpm	_____
Lower Limit	1200 rpm	_____
Accel Time	8 sec.	_____
Decel Time	3 sec.	_____
Raise Rate	2500 rpm/min.	_____
Lower Rate	2500 rpm/min.	_____
20 mA Remote Ref.	1890 rpm	_____
4 mA Remote Ref	1710 rpm	_____
Droop	5%	_____
Idle droop	0%	_____
Idle Droop break point	0%	_____
Speed Switch A On	600 rpm	_____
Speed Switch A Off	540 rpm	_____
Speed Switch B On	1200 rpm	_____
Speed Switch B Off	1140 rpm	_____
Speed Switch C On	2000 rpm	_____
Speed Switch C Off	1900 rpm	_____

Menu 4—Limiter Settings

IMPORTANT

Please refer to application note 51317, *ProAct Digital Speed Control System with Start-up Fuel Limiting*, if this is a fuel-limiting version.

Menu Item	Default Setting	Actual Setting
Max Fuel Limit	100%	_____
Transient Limit	0%	_____
Transient Time	0 sec.	_____
Start Fuel Limit	40%	_____
Start Ramp	1%/sec.	_____
Start Speed	400 rpm	_____
Min Torque Limit	50%	_____
Torque Limit BP	1500 rpm	_____
Torque Limit at BP	70%	_____
Max Torque Limit	90%	_____

Menu 6—Configuration Set Points

Menu Item	Default Setting	Actual Setting
Configuration Key	0	* _____
Number of Gear Teeth	60	_____
Dynamics Map	Linear	_____
Failsafe	Enabled	_____

*—Set at 49 to change menu tunables

ProAct Control Menu Summary

MENU 1—Dynamics Settings

Gain A
Gain A BP
Gain B
Gain B BP
Gain C
Gain C BP
Gain D
Gain D BP
Stability
Compensation
Gain Ratio
Window Width

MENU 2—Alternate Dynamics Settings

Alt Gain A
Alt Gain A BP
Alt Gain B
Alt Gain B BP
Alt Gain C
Alt Gain C BP
Alt Gain D
Alt Gain D BP
Alt Stability
Alt Compensation
Alt Gain Ratio
Alt Window Width

MENU 3—Speed Reference Settings

Rated Speed
Idle Speed
Raise Limit
Lower Limit
Accel Time
Decel Time
Raise Rate
Lower Rate
20 mA Remote Ref.
4 mA Remote Ref
Droop
Idle Droop
Idle Droop BP
Speed Switch A On
Speed Switch A Off
Speed Switch B On
Speed Switch B Off
Speed Switch C On
Speed Switch C Off

MENU 4—Limiter Settings

Max Fuel Limit
Transient Over Fuel
Transient Time
Start Fuel Limit
Start Ramp Rate
Start Speed
Min Torque Limit
Torque Limit BP
Torque Limit at BP
Max Torque Limit

MENU 5—Monitor Menu

Speed
Speed Reference
Actuator Output
Aux Input
Remote Input
Run/Stop Switch
Idle Rated Switch
Raise Switch
Lower Switch
Alternate Dynamics Switch
Remote Reference Switch
Isoch Switch
Diagnostic Switch
Speed Switch A
Speed Switch B
Speed Switch C
Fault Lamp

MENU 6—Configuration Set Points

*Configuration Key
Number of Gear Teeth
Dynamics Map
Failsafe Function

Be sure to save any changed set points before removing power from the control.

ProAct™ Control Specifications

Operating Temperature	-40 to +85 °C (-40 to +185 °F)
Storage Temperature	-55 to +100 °C (-67 to +212 °F)
Vibration	Sine Sweep, 6 hrs/axis, 24-2000 Hz 0.5 Oct./min input level 2.5 Gs
Shock	US MIL-STD-810C, Method 516.2, Procedure III
Transit Shock	US MIL-STD-810C, Method 516.2, Procedure IV
EMI/RFI:	
Conducted Susceptibility	
Frequency (Hz)	Amplitude (Vrms)
Power Leads— 30–1000	3.0
1000–10 000	3.5
10 000–8 000 000	1.5
8 000 000–1000 000 000	1.0
All other leads—	
30 000–500 000	0.5
500 000–1 000 000	1.0
Radiated Susceptibility:	Control will not fail in an unsafe manner up to 55 V/m, 15 kHz to 1000 MHz
Humidity:	95% ±5% at 60 °C for 6 hrs 50% ±5% at -40 °C for 2 hrs

We appreciate your comments about the content of our publications.

Send comments to: icinfo@woodward.com

Please reference publication **04121K**.



PO Box 1519, Fort Collins CO 80522-1519, USA
1000 East Drake Road, Fort Collins CO 80525, USA
Phone +1 (970) 482-5811 • Fax +1 (970) 498-3058

Email and Website—www.woodward.com

**Woodward has company-owned plants, subsidiaries, and branches,
as well as authorized distributors and other authorized service and sales facilities throughout the world.**

Complete address / phone / fax / email information for all locations is available on our website.